

OBIECT 3
DETALII DE EXECUTIE



MODERNIZARE TERASE EXISTENTE,
MONTARE TERMOSISTEM LA FATADE
SI EXTINDERE PE ORIZONTALA CU
CORPURI CONSTRUCTIE D SI E IN
REGIM P+2E+Er LA SCOALA
GIMNAZIALA NR. 30

BENEFICIAR:
SCOALA GIMNAZIALA NR.30 TIMISOARA,
STRADA ASTRILOR, NR. 13, TIMISOARA

ARHITECTURA
Faza: AC, PT, DE, LC, CS

**27. TAVANE SUSPENDATE INTERIOARE DIN
STRUCTURI DE GIPS CARTON IN CAMP
CONTINUU IN SPATII USCATE**

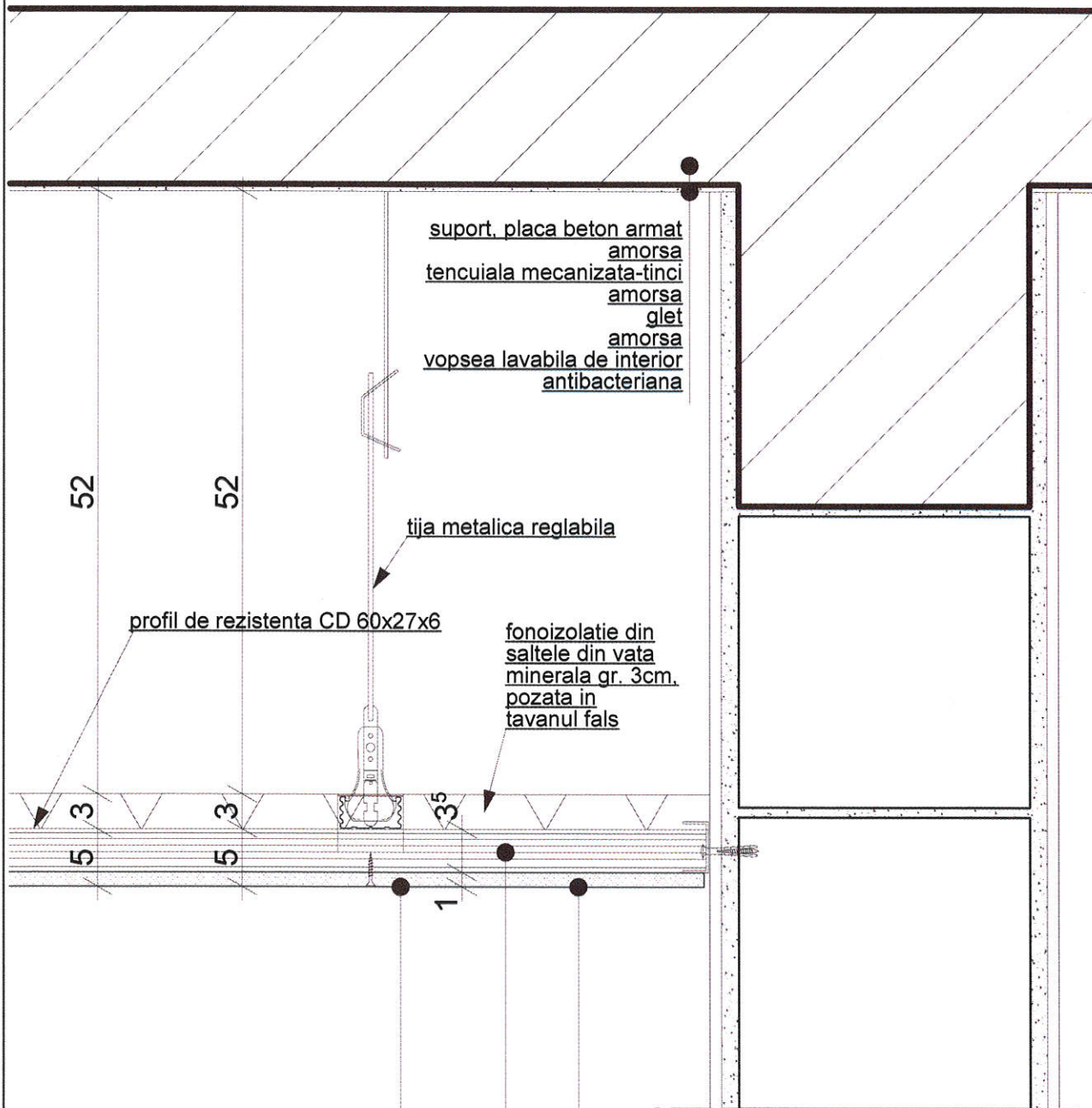

suport, placa beton armat
amorsa
tencuiala mecanizata-tinci
amorsa
glet
amorsa
vopsea lavabila de interior
antibacteriana

tija metalica reglabila

profil de rezistenta CD 60x27x6

fonoizolatie din
saltele din vata
minerala gr. 3cm,
pozata in
tavanul fals

placa gips-carton pentru spatii uscate

profil de montaj CD 60x27x6

vopsea lavabila de interior
antibacteriana

DETALIU SECTIUNE
SCARA 1:5

OBIECT 3
DETALII DE EXECUTIE

atelierul
ARHITEXT srl
adresa: localitatea Dumbrava, jud. Timis
Str. Mestescanului, nr.8

MODERNIZARE TERASE EXISTENTE,
MONTARE TERMOSISTEM LA FATADE
SI EXTINDERE PE ORIZONTALA CU
CORPURI CONSTRUCTIE D SI E IN
REGIM P+2E+Er LA SCOALA
GIMNAZIALA NR. 30

BENEFICIAR:
SCOALA GIMNAZIALA NR.30 TIMISOARA,
STRADA ASTRILOR, NR. 13, TIMISOARA

ARHITECTURA
Faza: AC, PT, DE, LC, CS

**28. TAVANE SUSPENDATE INTERIOARE
CASETATE IN SPATII UMEDE**

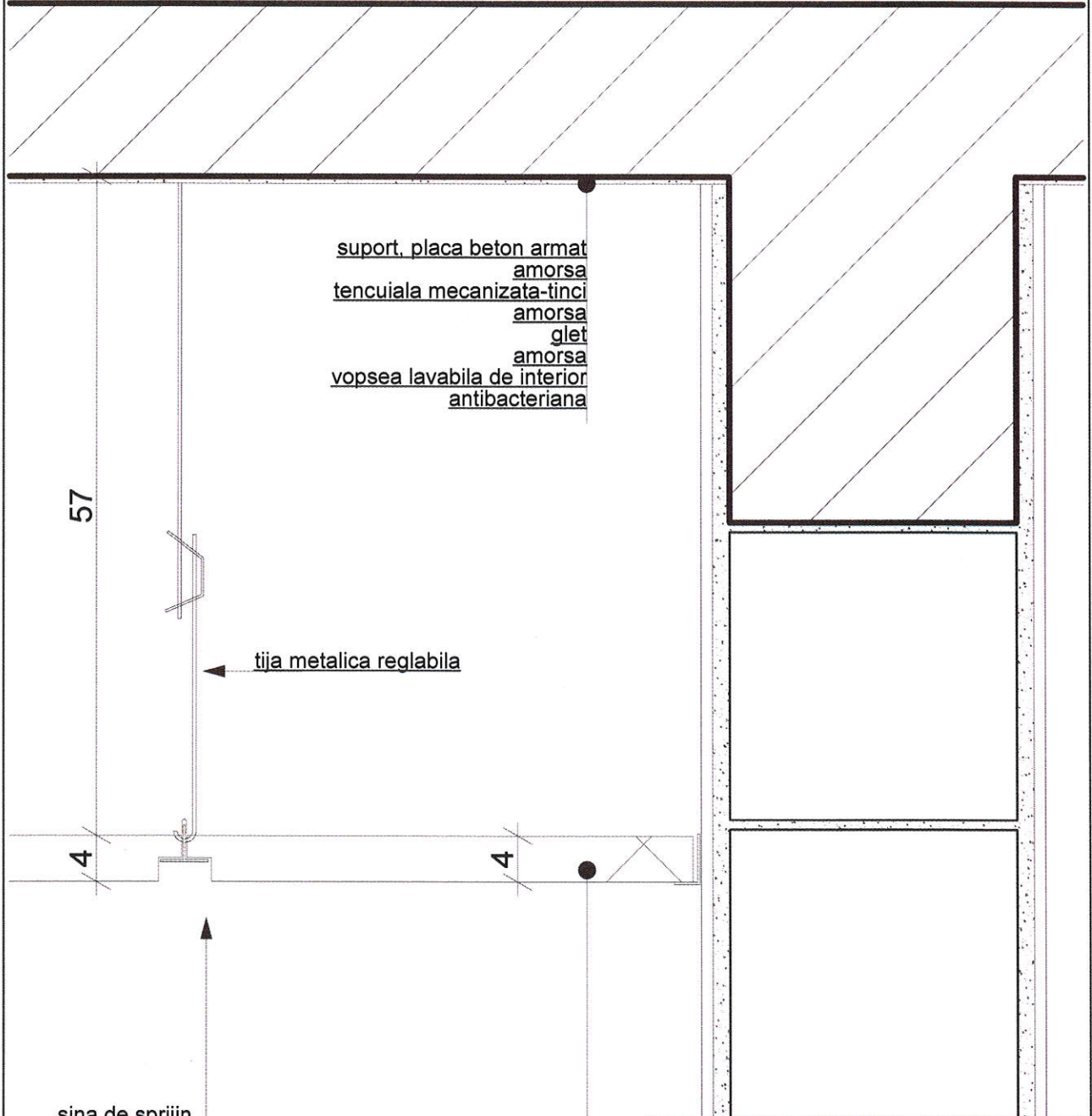

DETALIU SECTIUNE
SCARA 1:5

STAMP
OTIM B. VARDIA
329
Ing. Petru
POP
Arhitect
Str. ...

OBIECT 3

DETALII DE EXECUTIE



MODERNIZARE TERASE EXISTENTE,
MONTARE TERMOSISTEM LA FATADE
SI EXTINDERE PE ORIZONTALA CU
CORPURI CONSTRUCTIE D SI E IN
REGIM P+2E+Er LA SCOALA
GINNAZIALA NR. 30

BENEFICIAR:
SCOALA GIMNAZIALA NR.30 TIMISOARA,
STRADA ASTRILOR, NR. 13, TIMISOARA

ARHITECTURA
Faza: AC, PT, DE, LC, CS

29. TAVANE SUSPENDATE EXTERIOARE DIN STRUCTURI METALICE SI PLACI FIBRO BETON

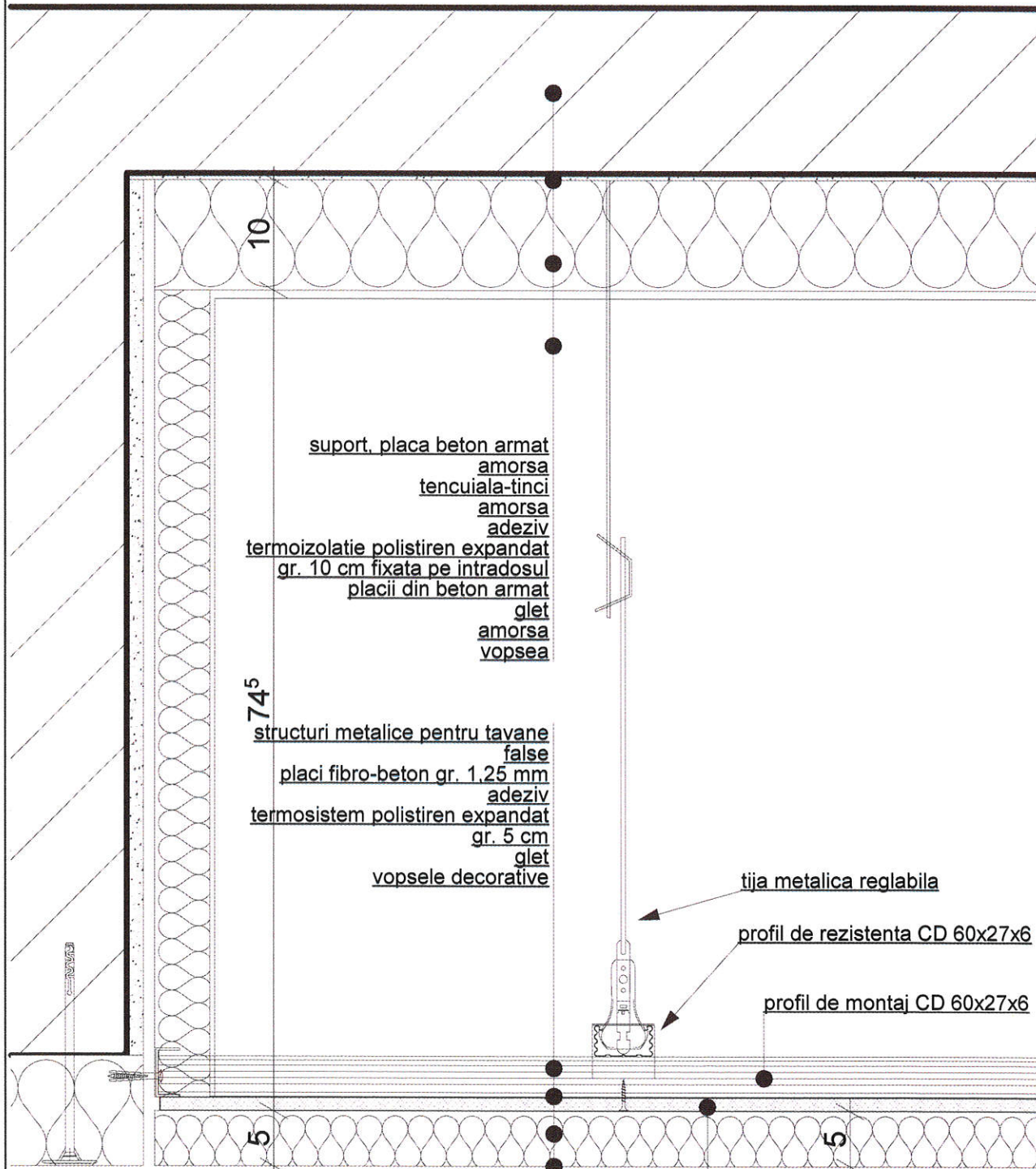

placi fibro beton 12.5mm

DETALIU SECTIUNE
SCARA 1:5

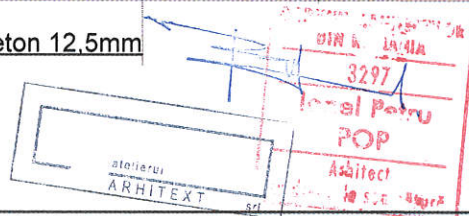

OBIECT 3
DETALII DE EXECUTIE

atelierul
ARHITEXT srl
adresa: localitatea Dumbravita, jud. Timis
Str. Mesteacanului, nr.8

MODERNIZARE TERASE EXISTENTE,
MONTARE TERMOSISTEM LA FATADE
SI EXTINDERE PE ORIZONTALA CU
CORPURI CONSTRUCTIE D SI E IN
REGIM P+2E+Er LA SCOALA
GIMNAZIALA NR. 30

BENEFICIAR:
SCOALA GIMNAZIALA NR.30 TIMISOARA,
STRADA ASTRILOR, NR. 13, TIMISOARA

ARHITECTURA
Faza: AC, PT, DE, LC, CS

**30. TAVANE SUSPENDATE INTERIOARE DIN
PLACI METALICE PERFORATE LAMELARE**

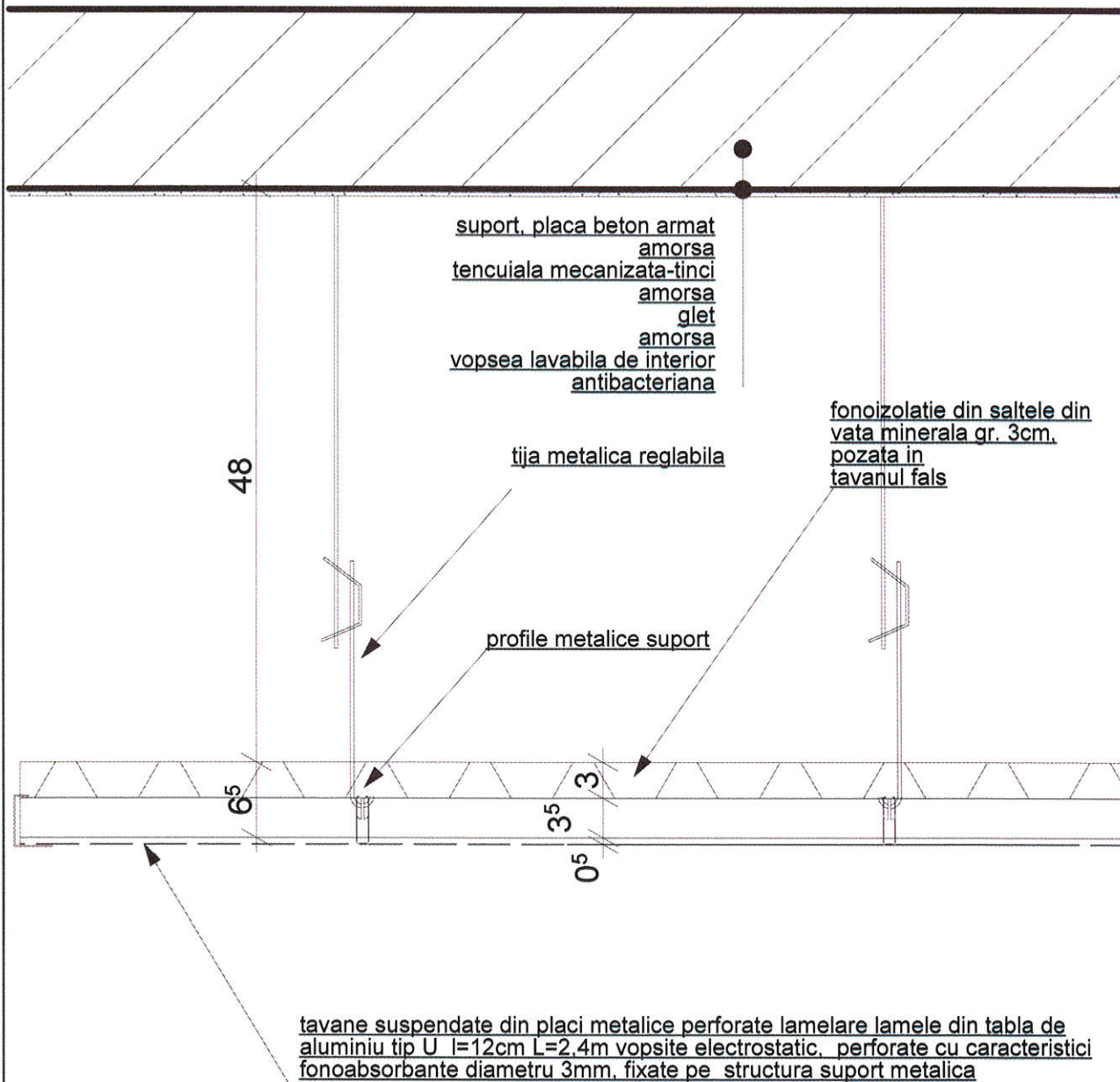

DETALIU SECTIUNE
SCARA 1:5

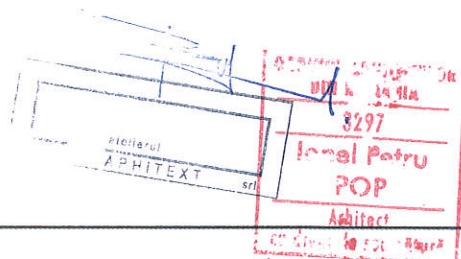

OBIECT 3

DETALII DE EXECUTIE



MODERNIZARE TERASE EXISTENTE,
MONTARE TERMOSISTEM LA FATADE
SI EXTINDERE PE ORIZONTALA CU
CORPURI CONSTRUCTIE D SI E IN
REGIM P+2E+Er LA SCOALA
GIMNAZIALA NR. 30

BENEFICIAR:
SCOALA GIMNAZIALA NR.30 TIMISOARA,
STRADA ASTRILOR, NR. 13, TIMISOARA

ARHITECTURA
Faza: AC, PT, DE, LC, CS

31. TAVANE CU TRATAMENTE ACUSTICE CORP D ETAJ 1 SI ETAJ 2 PE HOLURI

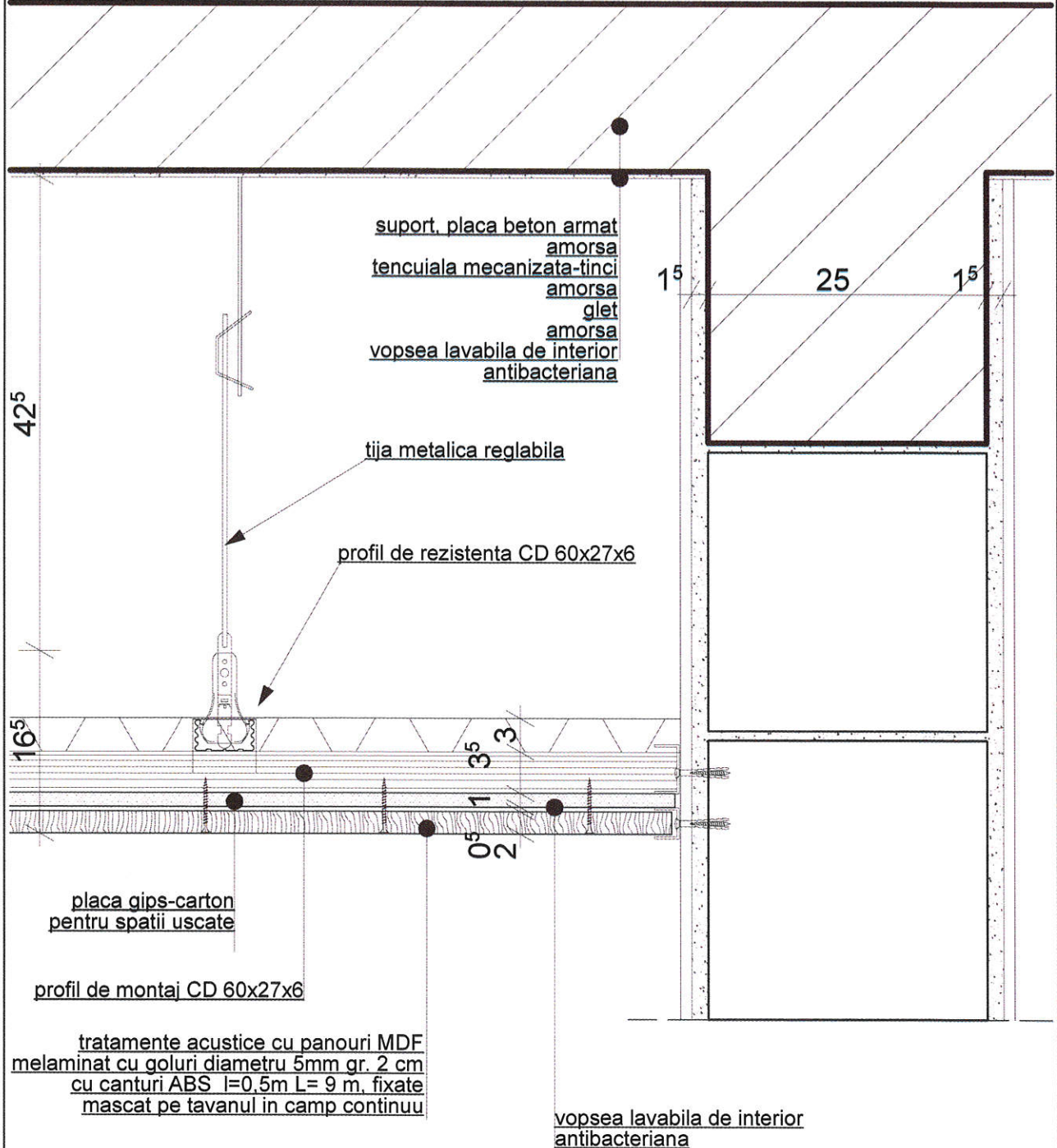

DETALIU SECTIUNE
SCARA 1:5

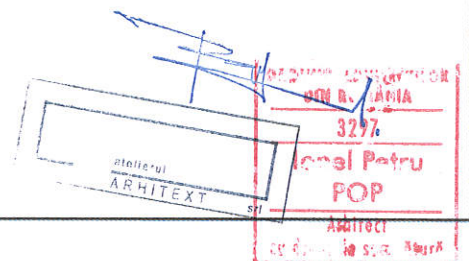

OBIECT 3

DETALII DE EXECUTIE

atelierul
ARHITEXT
adresa: localitatea Dumbravita, jud. Timis
Str. Mesteacanului, nr.8

MODERNIZARE TERASE EXISTENTE,
MONTARE TERMOSISTEM LA FATADE
SI EXTINDERE PE ORIZONTALA CU
CORPURI CONSTRUCTIE D SI E IN
REGIM P+2E+Er LA SCOALA
GIMNAZIALA NR. 30

BENEFICIAR:
SCOALA GIMNAZIALA NR.30 TIMISOARA,
STRADA ASTRILOR, NR. 13, TIMISOARA
ARHITECTURA
Faza: AC, PT, DE, LC, CS

32. TRATAMENTE ACUSTICE LA PERETI LABORATOARE DEMISOL CORP D

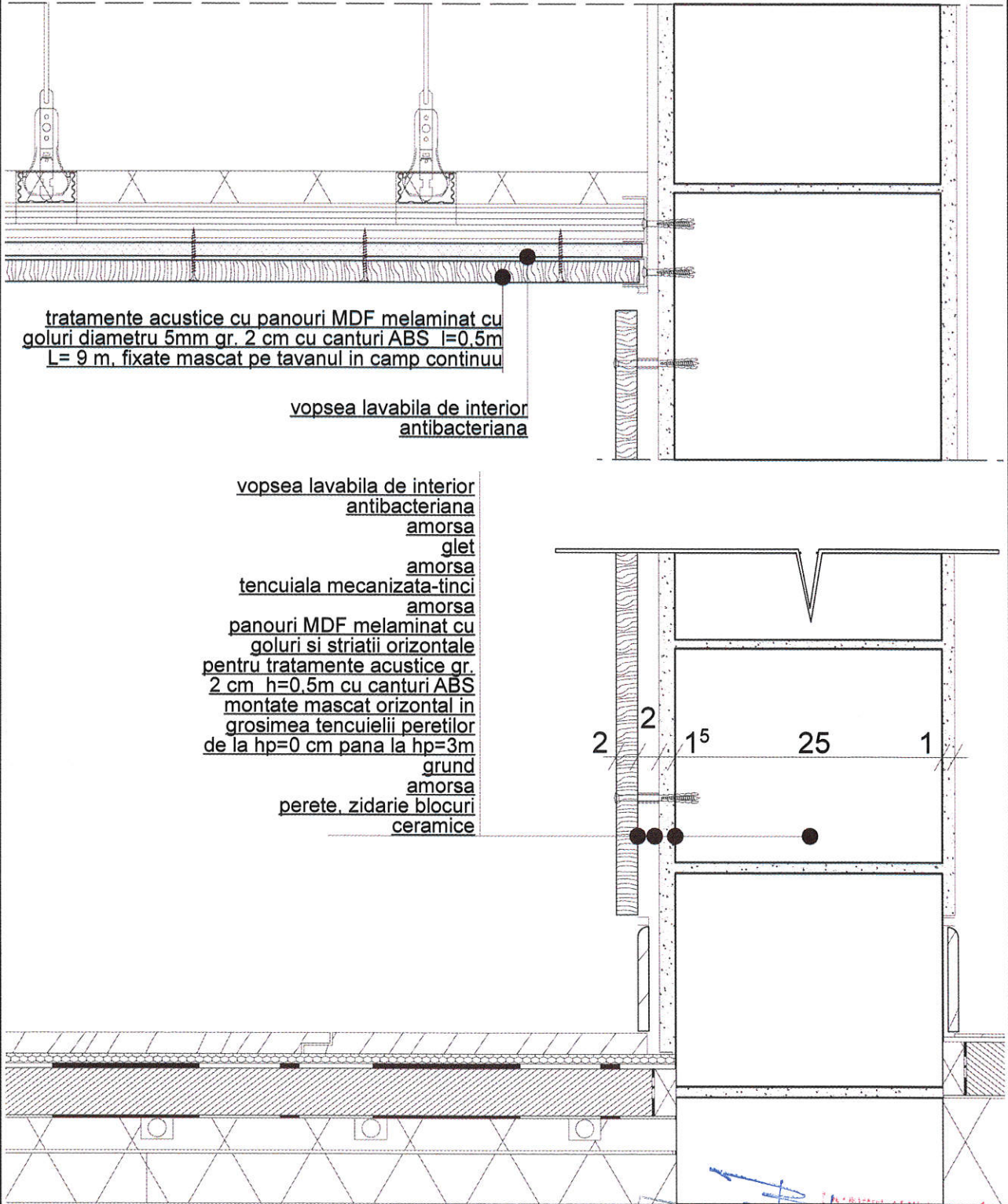

DETALIU SECTIUNE
SCARA 1:5

atelierul
ARHITEXT
3297
Ionel Patru
POP
Arhitect

OBIECT 3

DETALII DE EXECUTIE



MODERNIZARE TERASE EXISTENTE,
MONTARE TERMOSISTEM LA FATADE
SI EXTINDERE PE ORIZONTALA CU
CORPURI CONSTRUCTIE D SI E IN
REGIM P+2E+Er LA SCOALA
GIMNAZIALA NR. 30

BENEFICIAR:
SCOALA GIMNAZIALA NR.30 TIMISOARA,
STRADA ASTRILOR, NR. 13, TIMISOARA

ARHITECTURA
Faza: AC, PT, DE, LC, CS

33. TAVANE CU TRATAMENTE ACUSTICE LABORATOARE DEMISOL CORP D

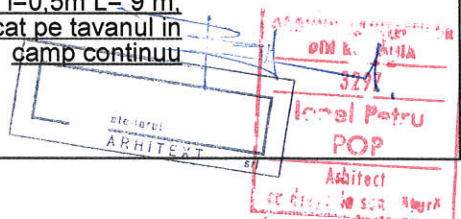
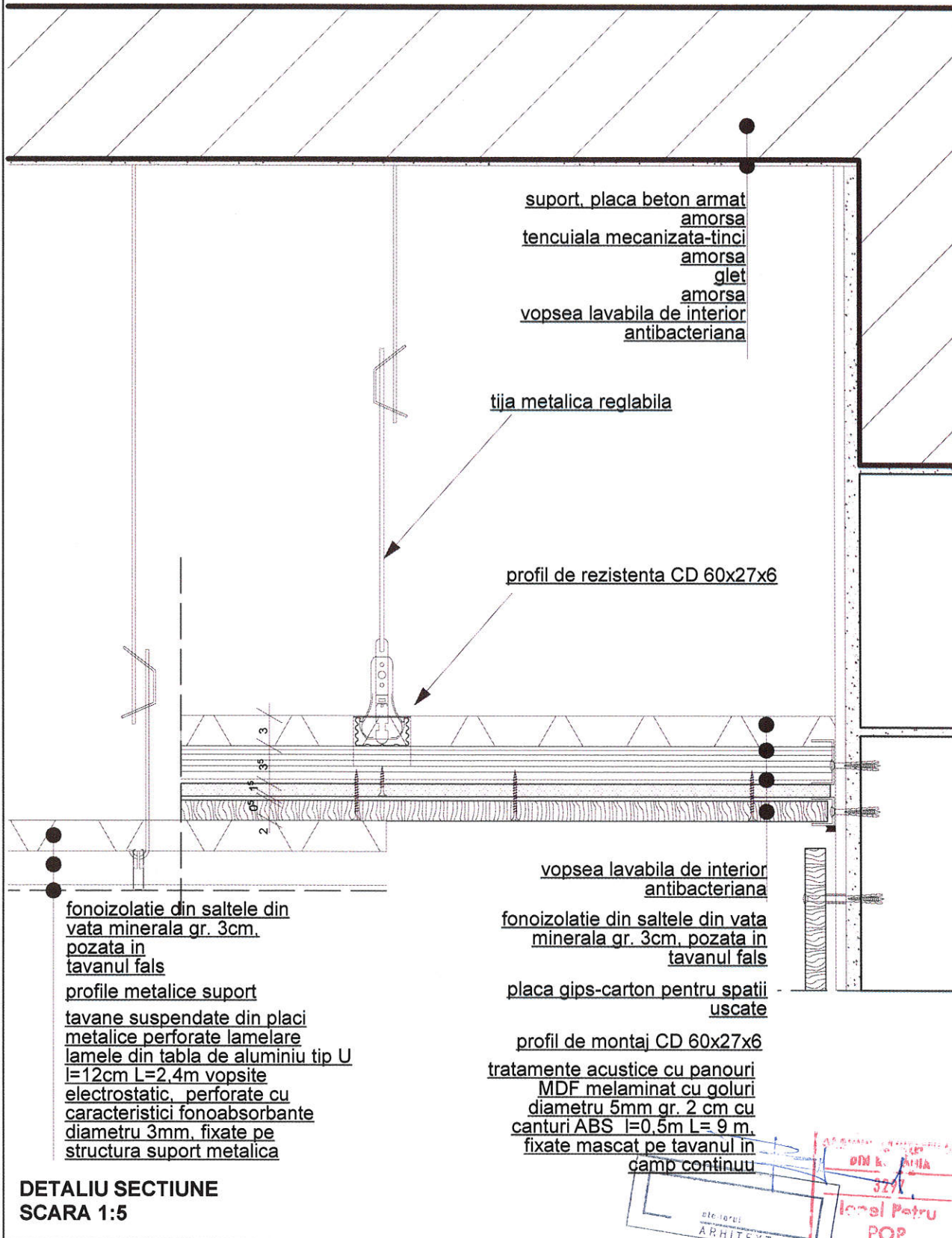

OBIECT 3

DETALII DE EXECUTIE

atelierul
ARHITEXT
adresa: localitatea Dumbravita, jud. Timis
Str. Mesteacanului, nr.8

MODERNIZARE TERASE EXISTENTE,
MONTARE TERMOSISTEM LA FATADE
SI EXTINDERE PE ORIZONTALA CU
CORPURI CONSTRUCTIE D SI E IN
REGIM P+2E+Er LA SCOALA
GIMNAZIALA NR. 30

BENEFICIAR:
SCOALA GIMNAZIALA NR.30 TIMISOARA,
STRADA ASTRILOR, NR. 13, TIMISOARA
ARHITECTURA
Faza: AC, PT, DE, LC, CS

34. TRATAMENTE ACUSTICE LA PERETI HOL PARTER CORP D

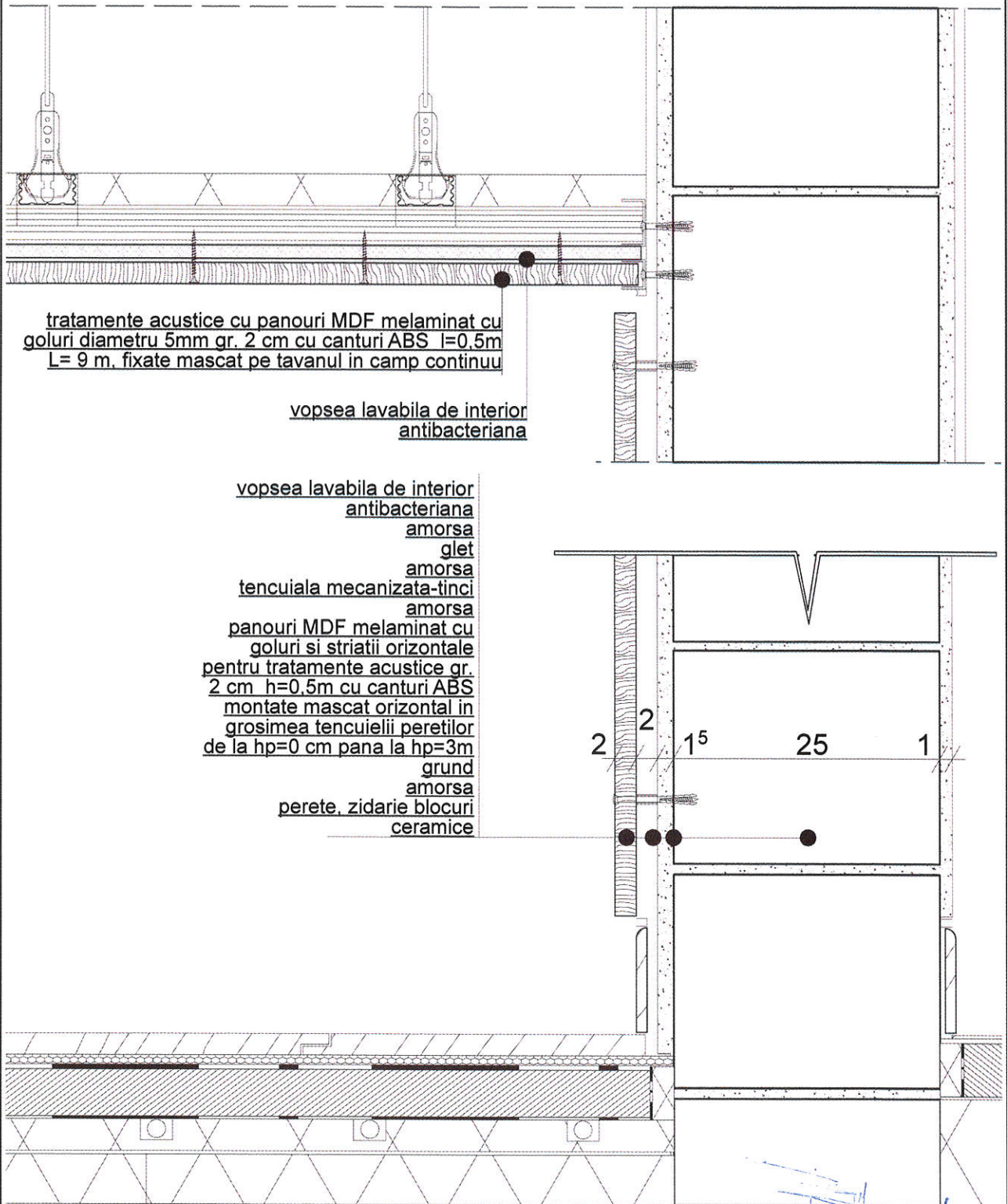

DETALIU SECTIUNE
SCARA 1:5

atelierul
ARHITEXT

DIN 1/10/2006
3297
Ionel Petru
POP
Arhitect
P.O. Box 10000 Timisoara

OBIECT 3

DETALII DE EXECUTIE



MODERNIZARE TERASE EXISTENTE,
MONTARE TERMOSISTEM LA FATADE
SI EXTINDERE PE ORIZONTALA CU
CORPURI CONSTRUCTIE D SI E IN
REGIM P+2E+Er LA SCOALA
GIMNAZIALA NR. 30

BENEFICIAR:
SCOALA GIMNAZIALA NR.30 TIMISOARA,
STRADA ASTRILOR, NR. 13, TIMISOARA
ARHITECTURA
Faza: AC, PT, DE, LC, CS

35. TRATAMENTE ACUSTICE LA TAVAN HOL PARTER CORP D

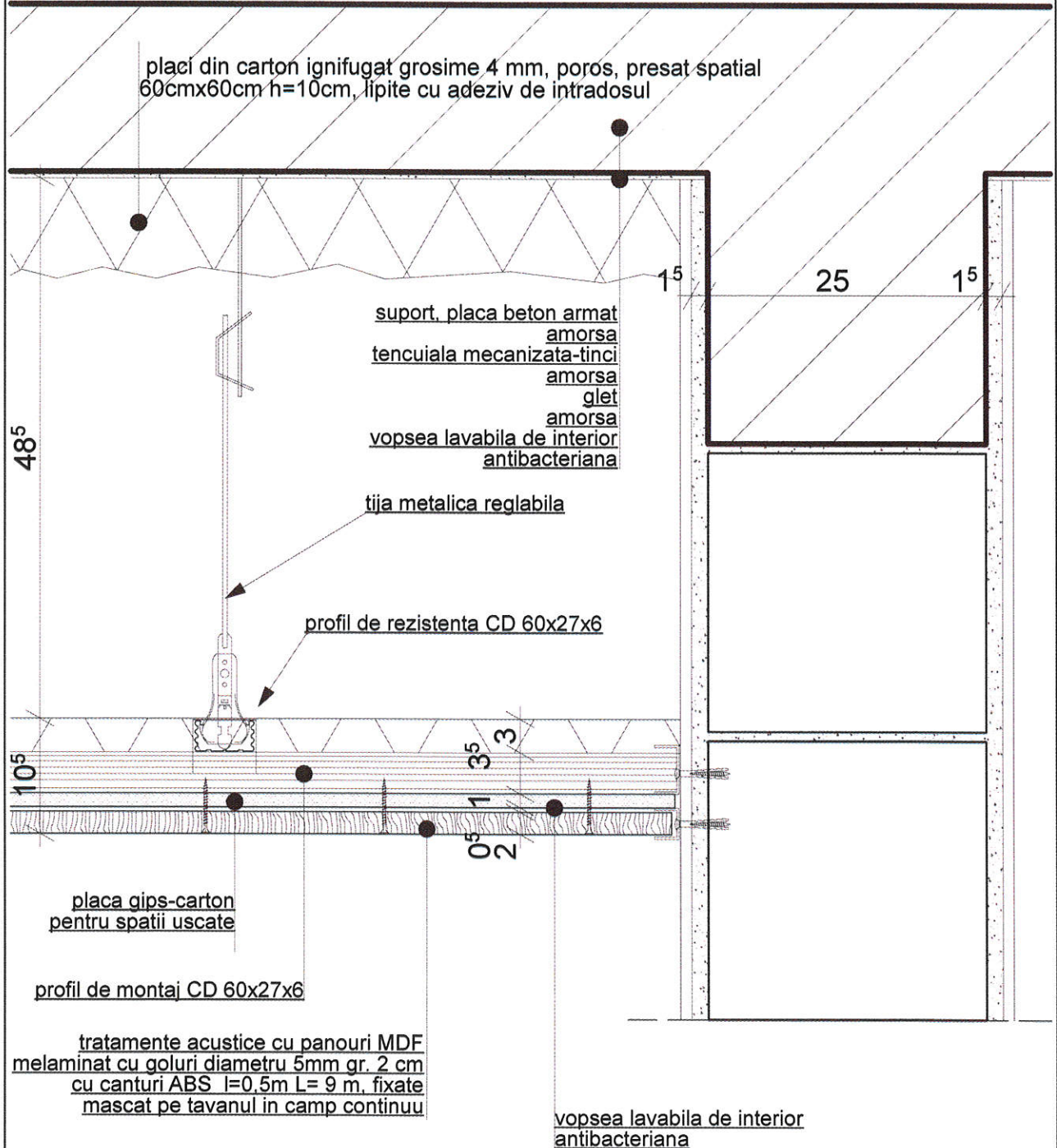

DETALIU SECTIUNE
SCARA 1:5

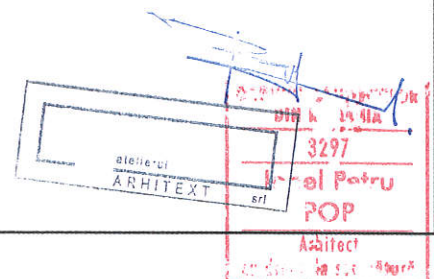

OBIECT 3

DETALII DE EXECUTIE



MODERNIZARE TERASE EXISTENTE,
MONTARE TERMOSISTEM LA FATADE
SI EXTINDERE PE ORIZONTALA CU
CORPURI CONSTRUCTIE D SI E IN
REGIM P+2E+Er LA SCOALA
GIMNAZIALA NR. 30

BENEFICIAR:
SCOALA GIMNAZIALA NR.30 TIMISOARA,
STRADA ASTRILOR, NR. 13, TIMISOARA

ARHITECTURA
Faza: AC, PT, DE, LC, CS

36. TRATAMENTE ACUSTICE LA PERETI HOLURI DE NIVEL CORP D ETAJ 1 SI ETAJ 2

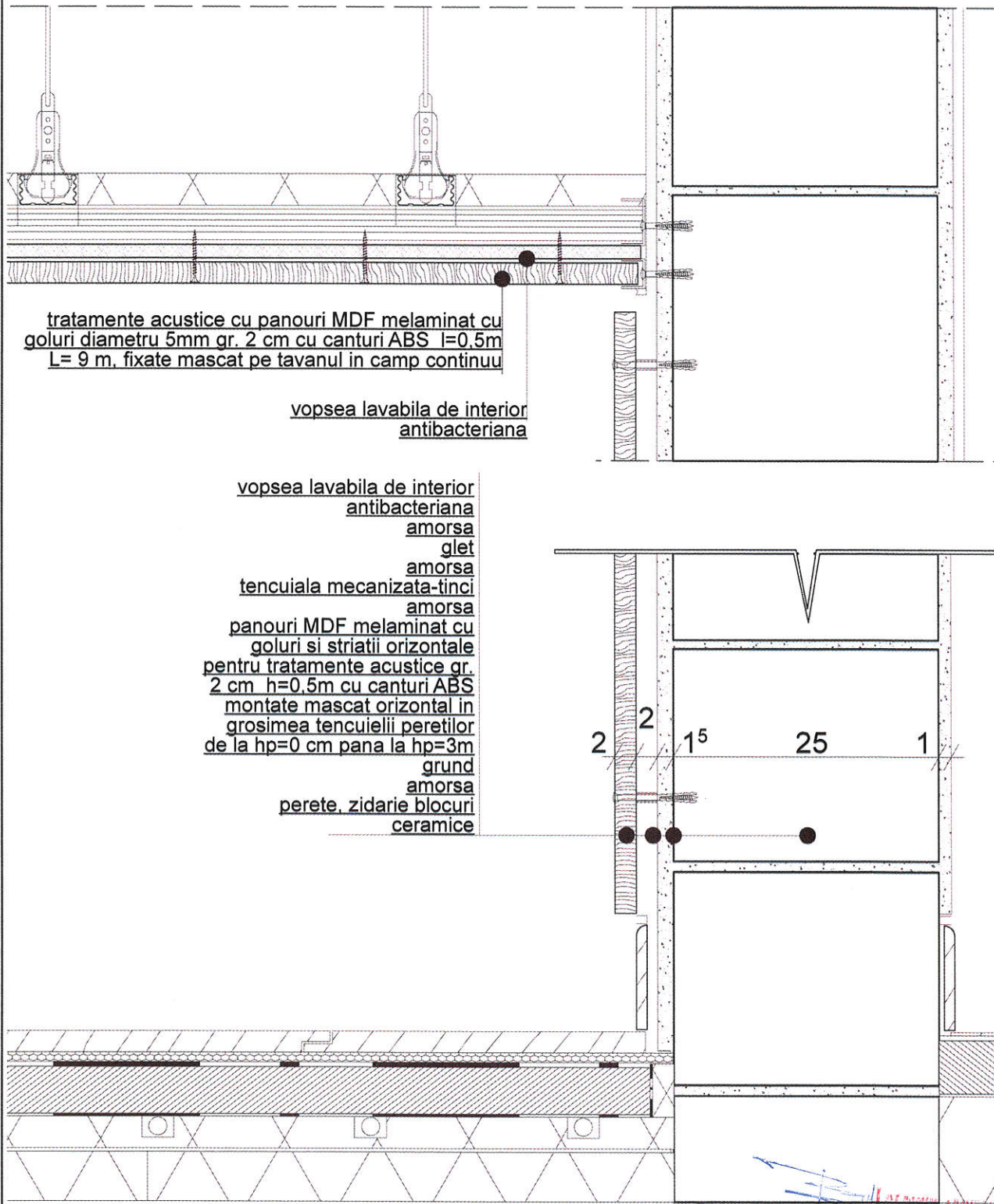

tratamente acustice cu panouri MDF melaminat cu
goluri diametru 5mm gr. 2 cm cu canturi ABS l=0.5m
L= 9 m, fixate mascat pe tavanul in camp continuu

vopsea lavabila de interior
antibacteriana

vopsea lavabila de interior
antibacteriana
amorsa
glet
amorsa
tencuiala mecanizata-tinci
amorsa
panouri MDF melaminat cu
goluri si striatii orizontale
pentru tratamente acustice gr.
2 cm h=0.5m cu canturi ABS
montate mascat orizontal in
grosimea tencuiei peretilor
de la hp=0 cm pana la hp=3m
grund
amorsa
perete, zidarie blocuri
ceramice

DETALIU SECTIUNE
SCARA 1:5

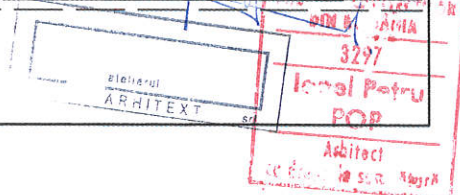

OBIECT 3

DETALII DE EXECUTIE



MODERNIZARE TERASE EXISTENTE,
MONTARE TERMOSISTEM LA FATADE
SI EXTINDERE PE ORIZONTALA CU
CORPURI CONSTRUCTIE D SI E IN
REGIM P+2E+Er LA SCOALA
GIMNAZIALA NR. 30

BENEFICIAR:
SCOALA GIMNAZIALA NR.30 TIMISOARA,
STRADA ASTRILOR, NR. 13, TIMISOARA

ARHITECTURA
Faza: AC, PT, DE, LC, CS

37.FINISAJE EXTERIOARE TERMOSISTEM SI VOPSELE DECORATIVE CORP D (DE LA COTA -120 PANA LA COTA +12,24)

termosistem din placi
de polistiren expandat
grafitat gr. 10 cm

glet de exterior, masa
de spaclu pe fibra de
sticla, profile de colt

vopsele decorative de exterior
termosistem din placi
rigide bazaltice gr. 10 cm

profil cu picurator

bariera termica

vitrine cu tamplarie din aluminiu
realizata din profile cu bariera
termica cu ochiuri fixe si mobile,
cu garnitura de etanseizare
EPDM, cu geam termoizolant cu
sticla laminata

DETALIU SECTIUNE SCARA 1:5

glaf exterior, aluminiu, vopsit
electrostatic

termosistem din placi
de polistiren expandat
grafitat gr. 10 cm

spuma poliuretanică

blat interior, mdf
melaminat

DETALIU SECTIUNE -PROPUS SCARA 1:5



OBIECT 3
DETALII DE EXECUTIE



MODERNIZARE TERASE EXISTENTE,
MONTARE TERMOSISTEM LA FATADE
SI EXTINDERE PE ORIZONTALA CU
CORPURI CONSTRUCTIE D SI E IN
REGIM P+2E+Er LA SCOALA
GIMNAZIALA NR. 30

BENEFICIAR:
SCOALA GIMNAZIALA NR.30 TIMISOARA,
STRADA ASTRILOR, NR. 13, TIMISOARA
ARHITECTURA
Faza: AC, PT, DE, LC, CS

**38. PLACAJE DIN FOI DE ALUMINIU
COMPOZIT LA PARTER CORP D**



DETALIU SECTIUNE -PROPOS
SCARA 1:5

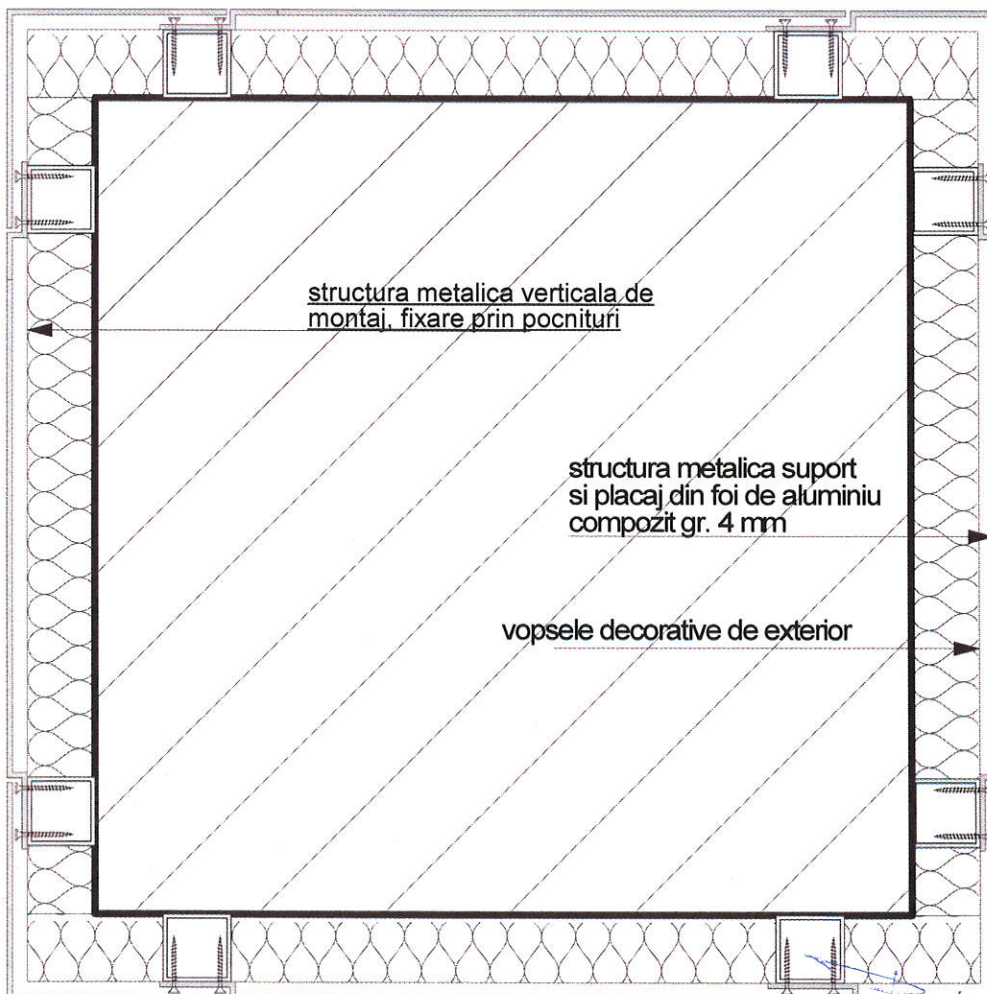

DETALIU PLAN -PROPOS
SCARA 1:5

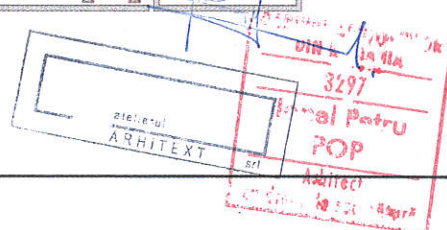

OBIECT 3

DETALII DE EXECUTIE



MODERNIZARE TERASE EXISTENTE,
MONTARE TERMOSISTEM LA FATADE
SI EXTINDERE PE ORIZONTALA CU
CORPURI CONSTRUCTIE D SI E IN
REGIM P+2E+Er LA SCOALA
GIMNAZIALA NR. 30

BENEFICIAR:
SCOALA GIMNAZIALA NR.30 TIMISOARA,
STRADA ASTRILOR, NR. 13, TIMISOARA

ARHITECTURA
Faza: AC, PT, DE, LC, CS

39. PERETE SI FINISAJE EXTERIOARE PERETE DECORATIV ACCES CORP D

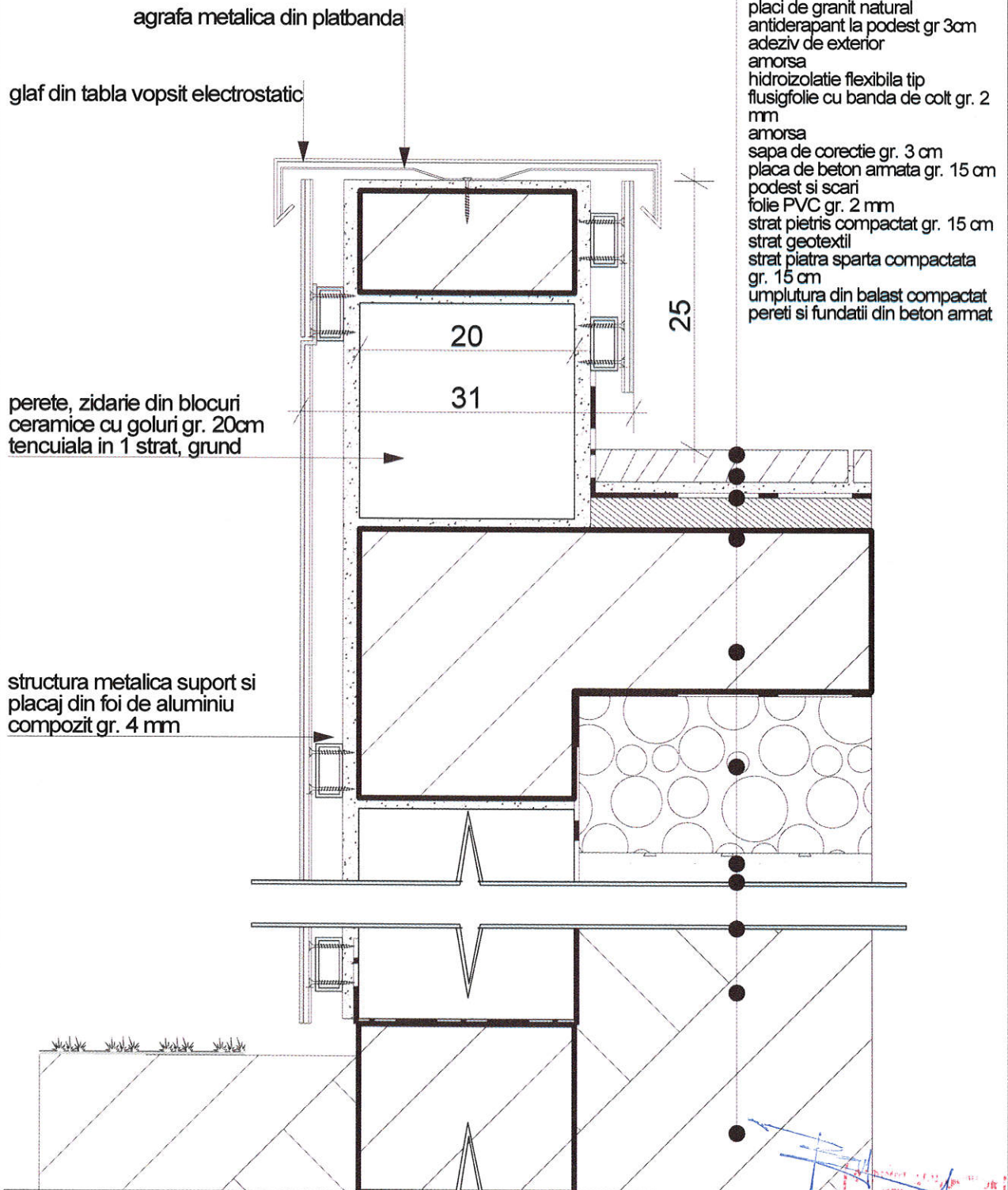

DETALIU SECTIUNE
SCARA 1:5

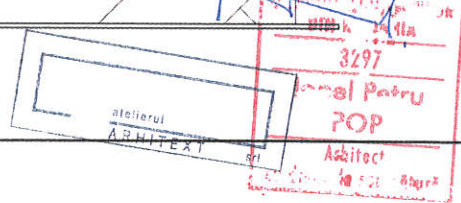

OBIECT 3

DETALII DE EXECUTIE

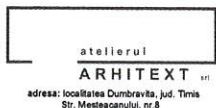

MODERNIZARE TERASE EXISTENTE,
MONTARE TERMOSISTEM LA FATADE
SI EXTINDERE PE ORIZONTALA CU
CORPURI CONSTRUCTIE D SI E IN
REGIM P+2E+Er LA SCOALA
GIMNAZIALA NR. 30

BENEFICIAR:
SCOALA GIMNAZIALA NR.30 TIMISOARA,
STRADA ASTRILOR, NR. 13, TIMISOARA

ARHITECTURA
Faza: AC, PT, DE, LC, CS

40.a. BALUSTRADA DE PROTECTIE LA TERASA PARTER CORP D

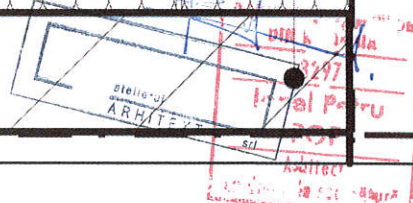
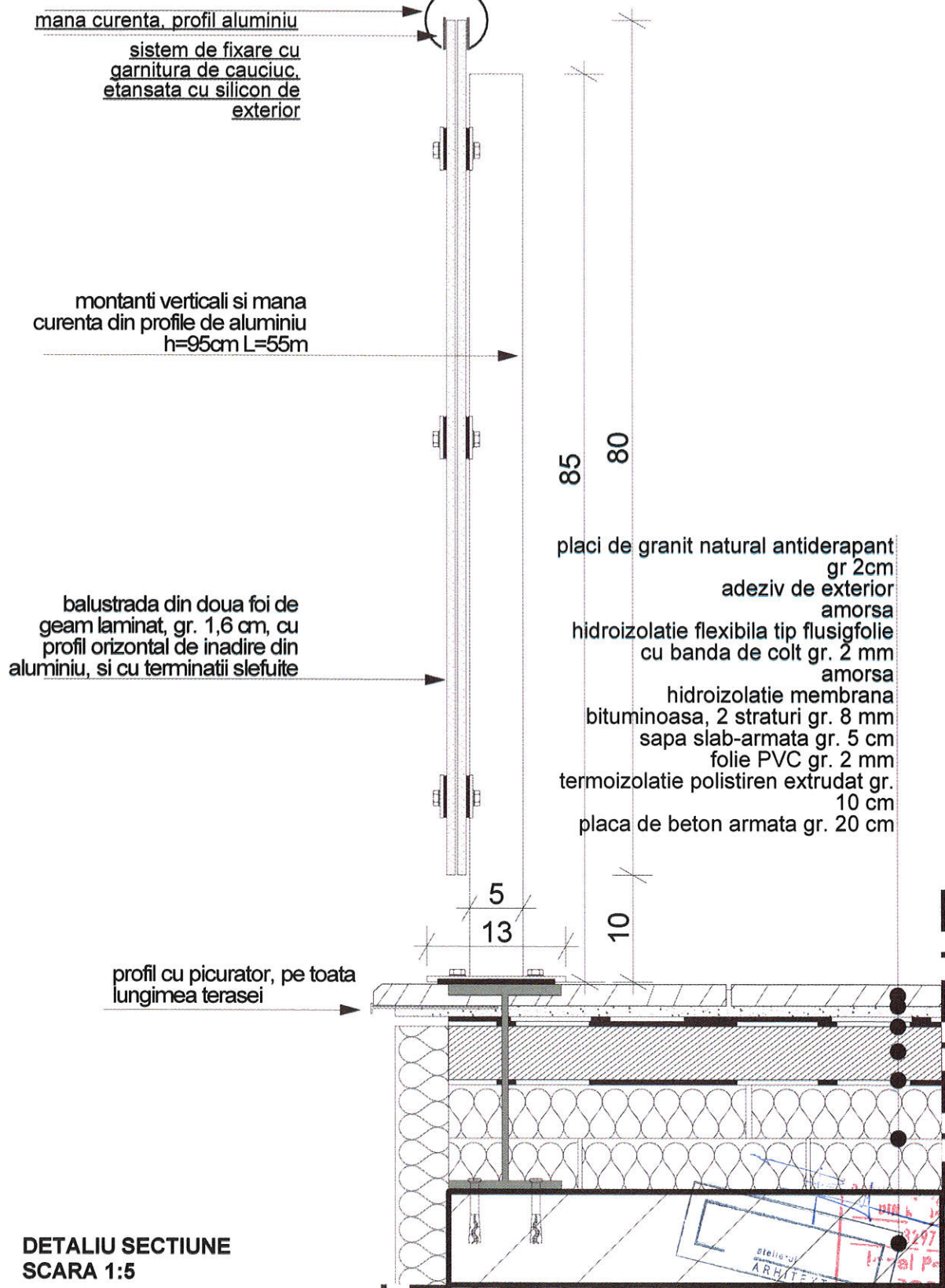

OBIECT 3

DETALII DE EXECUTIE

atelierul
ARHITEXT srl
adresa: localitatea Dumbravita, jud. Timis
Str. Mesteacanului, nr.8

MODERNIZARE TERASE EXISTENTE,
MONTARE TERMOSISTEM LA FATADE
SI EXTINDERE PE ORIZONTALA CU
CORPURI CONSTRUCTIE D SI E IN
REGIM P+2E+Er LA SCOALA
GIMNAZIALA NR. 30

BENEFICIAR:
SCOALA GIMNAZIALA NR.30 TIMISOARA,
STRADA ASTRILOR, NR. 13, TIMISOARA

ARHITECTURA
Faza: AC, PT, DE, LC, CS

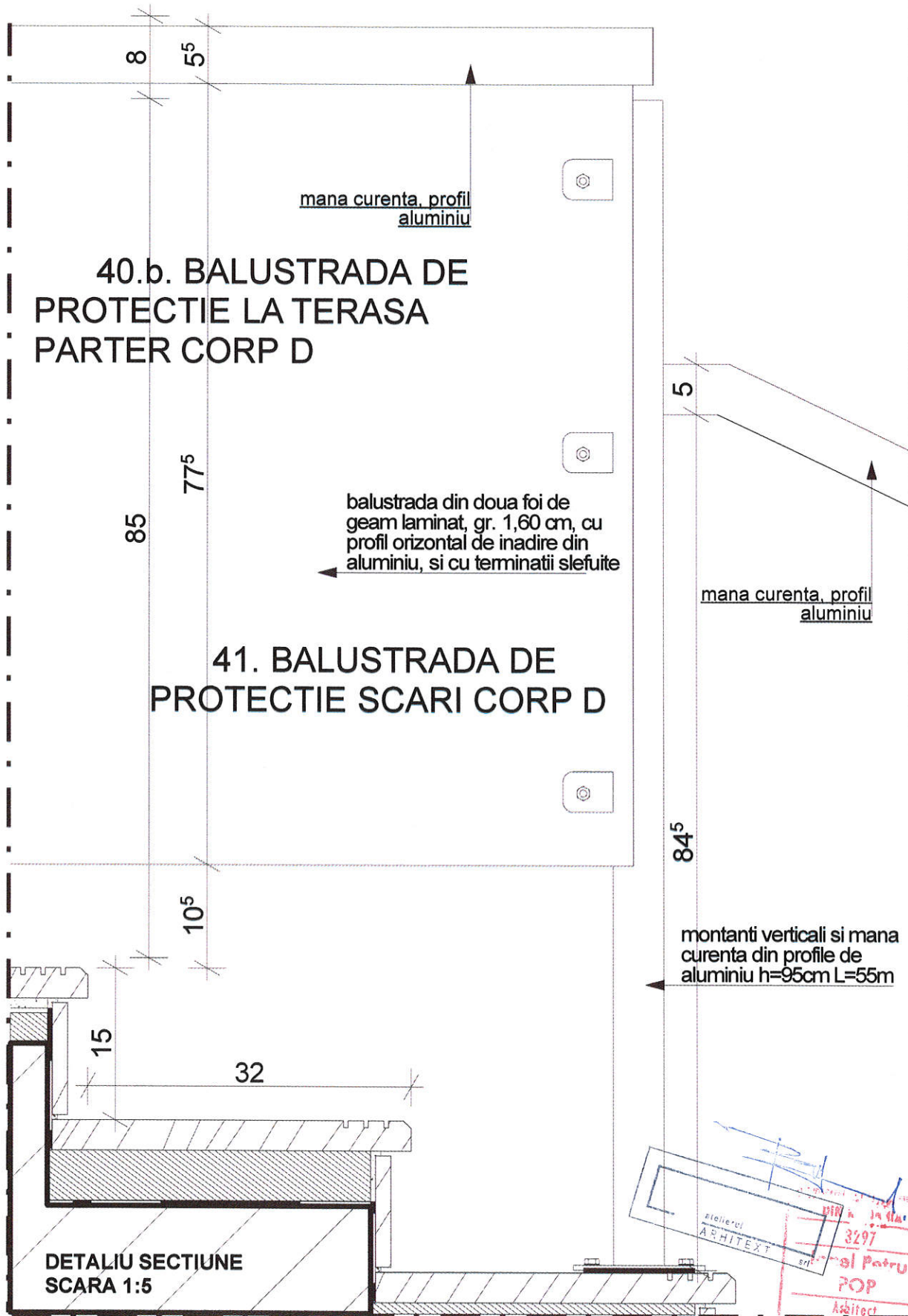

atelierul
ARHITEXT srl
3297
Pop
Arhitect

OBIECT 3

DETALII DE EXECUTIE

atelierul
ARHITEXT SRL
adresa: localitatea Dumbravita, jud. Timis
Str. Mostescanului, nr.8

MODERNIZARE TERASE EXISTENTE,
MONTARE TERMOSISTEM LA FATADE
SI EXTINDERE PE ORIZONTALA CU
CORPURI CONSTRUCTIE D SI E IN
REGIM P+2+Er LA SCOALA
GIMNAZIALA NR. 30

BENEFICIAR:
SCOALA GIMNAZIALA NR.30 TIMISOARA,
STRADA ASTRILOR, NR. 13, TIMISOARA
ARHITECTURA
Faza: AC, PT, DE, LC, CS

41. BALUSTRADE DE PROTECTIE LA SCARI CORP D

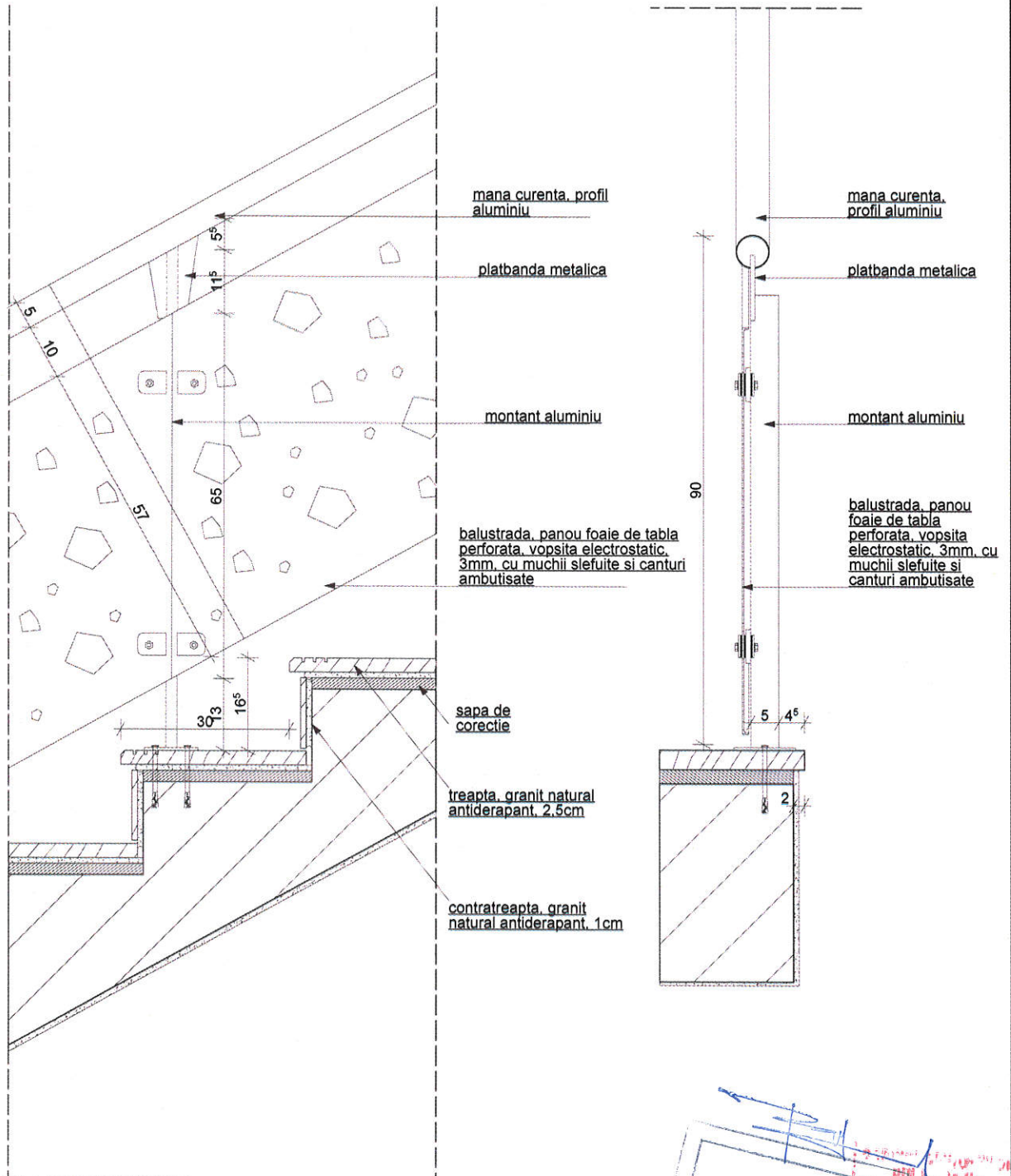

DETALIU SECTIUNE
SCARA 1:10

ARHITECT
3297
Armel Patru
POP
Arhitect

OBIECT 3
DETALII DE EXECUTIE



MODERNIZARE TERASE EXISTENTE,
MONTARE TERMOSISTEM LA FATADE
SI EXTINDERE PE ORIZONTALA CU
CORPURI CONSTRUCTIE D SI E IN
REGIM P+2E+Er LA SCOALA
GIMNAZIALA NR. 30

BENEFICIAR:
SCOALA GIMNAZIALA NR.30 TIMISOARA,
STRADA ASTRILOR, NR. 13, TIMISOARA
ARHITECTURA
Faza: AC, PT, DE, LC, CS

**42. BALUSTRADA DE
PROTECTIE LA SCARA CURTE
DEMISOL ACCES TEHNIC CORP D**

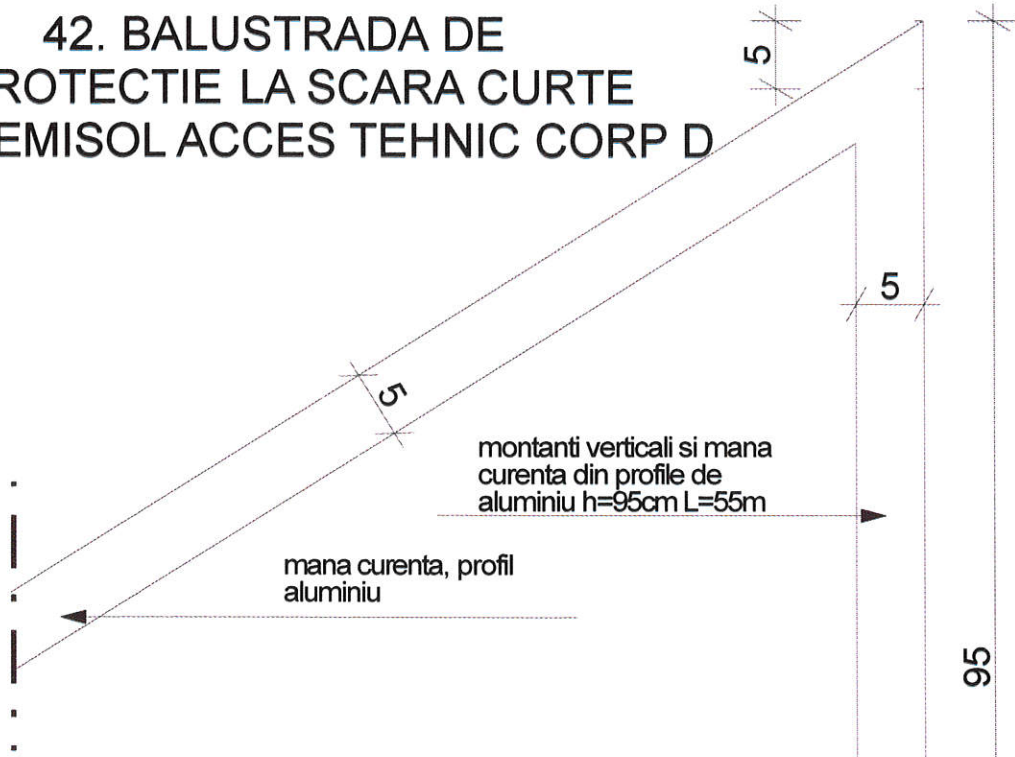

**DETALIU SECTIUNE
SCARA 1:5**

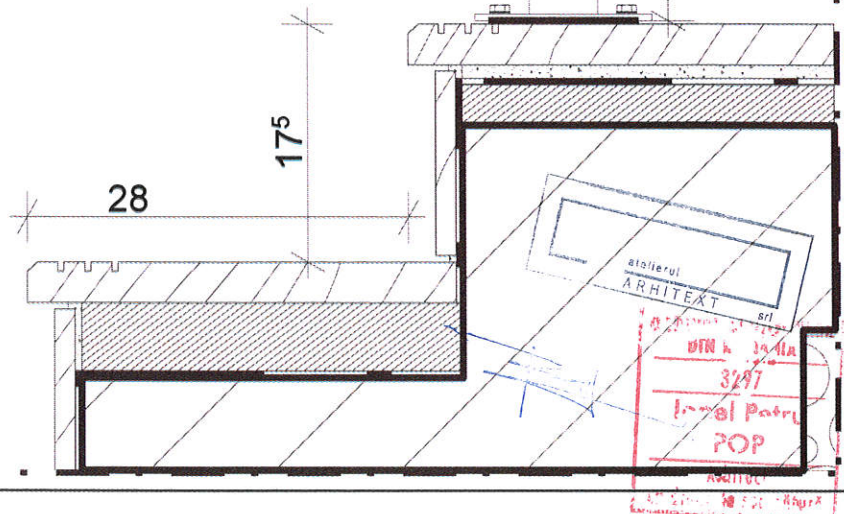

OBIECT 3
DETALII DE EXECUTIE

atelierul
ARHITEXT SRL
adresa: localitatea Dumbravita, jud. Timis
Str. Mesteacanului, nr.8

MODERNIZARE TERASE EXISTENTE,
MONTARE TERMOSISTEM LA FATADE
SI EXTINDERE PE ORIZONTALA CU
CORPURI CONSTRUCTIE D SI E IN
REGIM P+2E+Er LA SCOALA
GIMNAZIALA NR. 30

BENEFICIAR:
SCOALA GIMNAZIALA NR.30 TIMISOARA,
STRADA ASTRILOR, NR. 13, TIMISOARA
ARHITECTURA
Faza: AC, PT, DE, LC, CS

**43. IZOLATII SI FINISAJE LA PERTI DE INCHIDERE
DEMISOL CORP D**

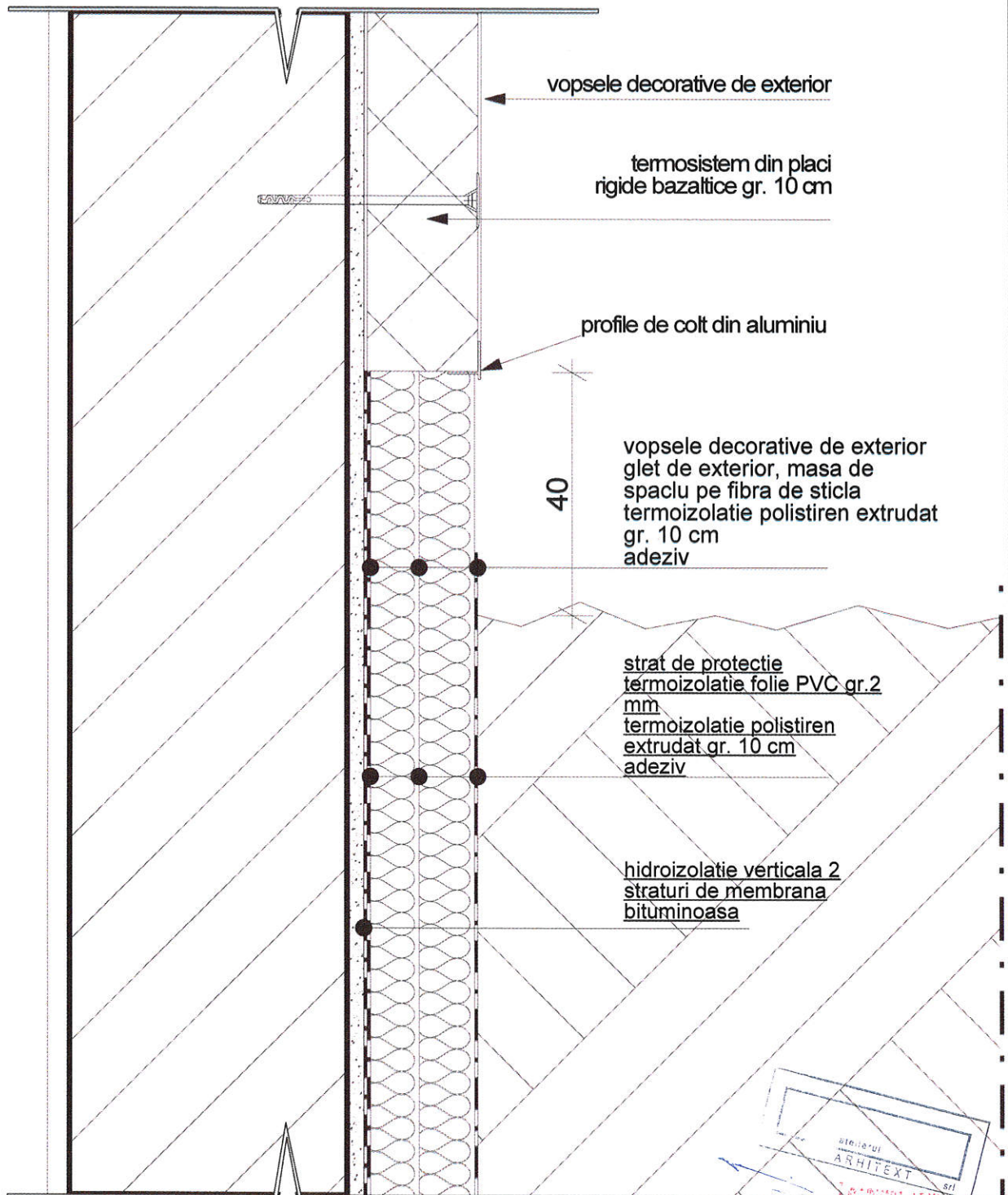

DETALIU SECTIUNE
SCARA 1:5

atelierul
ARHITEXT SRL
DIR. k. j. n. n.
3297
Ingal Petru
POP
Arhitect

OBIECT 3

DETALII DE EXECUTIE



MODERNIZARE TERASE EXISTENTE,
MONTARE TERMOSISTEM LA FATADE
SI EXTINDERE PE ORIZONTALA CU
CORPURI CONSTRUCTIE D SI E IN
REGIM P+2E+Er LA SCOALA
GIMNAZIALA NR. 30

BENEFICIAR:
SCOALA GIMNAZIALA NR.30 TIMISOARA,
STRADA ASTRILOR, NR. 13, TIMISOARA

ARHITECTURA
Faza: AC, PT, DE, LC, CS

44. IZOLATII SI FINISAJE LA PERETE DE SPRIJIN CURTE DEMISOL ACCES TEHNIC CORP D

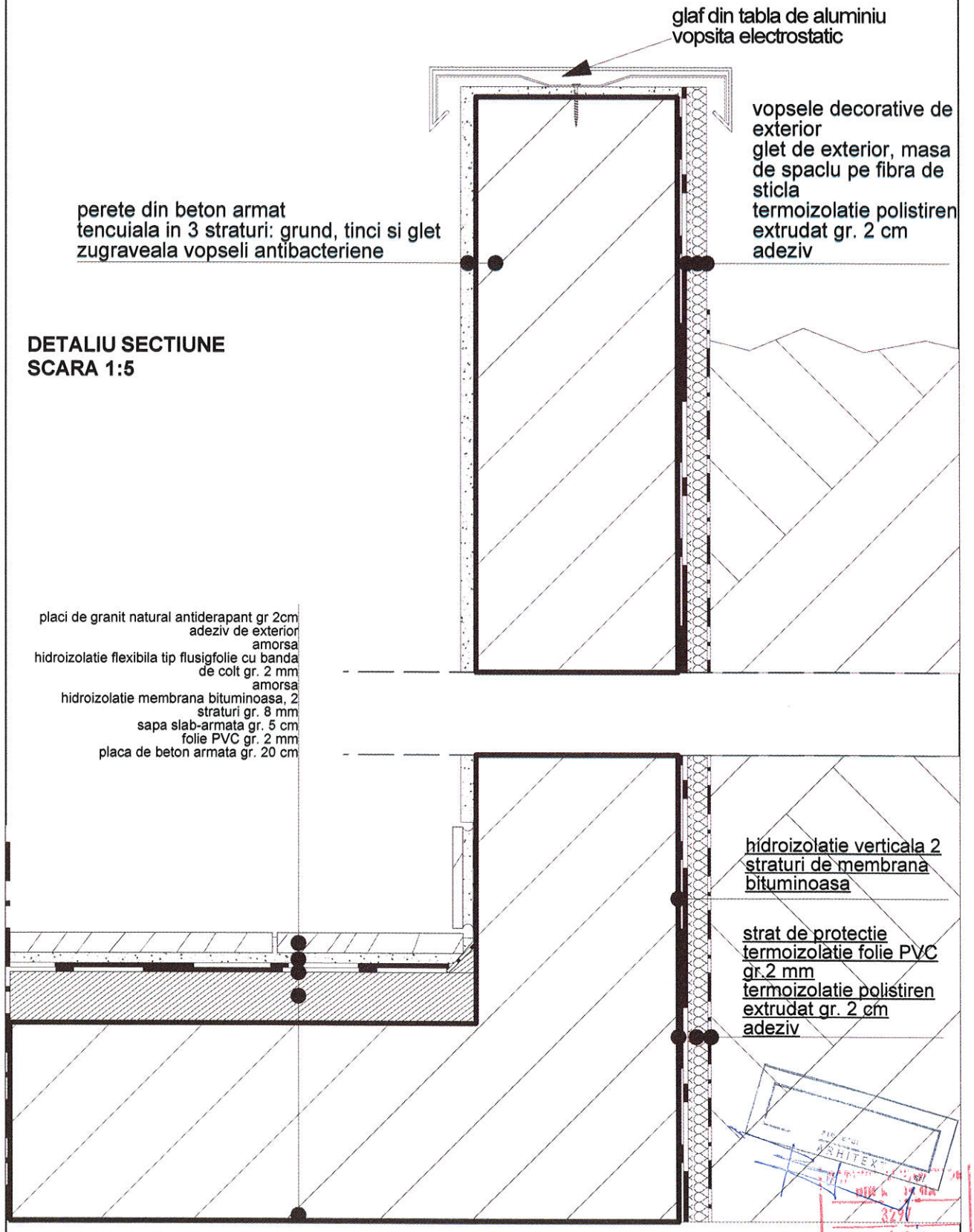

DETALIU SECTIUNE
SCARA 1:5



OBIECT 3

DETALII DE EXECUTIE



MODERNIZARE TERASE EXISTENTE,
MONTARE TERMOSISTEM LA FATADE
SI EXTINDERE PE ORIZONTALA CU
CORPURI CONSTRUCTIE D SI E IN
REGIM P+2E+Er LA SCOALA
GIMNAZIALA NR. 30

BENEFICIAR:
SCOALA GIMNAZIALA NR.30 TIMISOARA,
STRADA ASTRILOR, NR. 13, TIMISOARA

ARHITECTURA
Faza: AC, PT, DE, LC, CS

45. PERETI SI FINISAJE EXTERIOARE LA ATICE CORP D

agrafa metalica din platbanda
glaf din tabla vopsit electrostatic

DETALIU SECTIUNE
SCARA 1:5

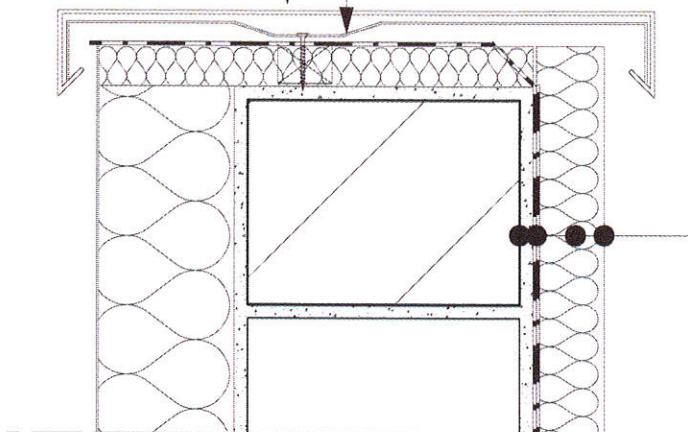

perete din zidarie din blocuri
ceramice cu goluri
tencuiala 1 strat: grunt
suport hidroizolatie verticala
amorsa
strat DDC
hidroizolatie verticala 2
straturi membrana
bituminoasa
(racordata la hidroizolatia
orizontala terasa)
adeziv
termoizolatie polistiren
expandat gr. 5 cm
glet de exterior, masa
de spaclu pe fibra de sticla,
profile de colt
vopsele decorative

termosistem
din placi de
polistiren
expandat
grafitat gr. 10
cm

glet de
exterior, masa
de spaclu pe
fibra de sticla,
profile de colt

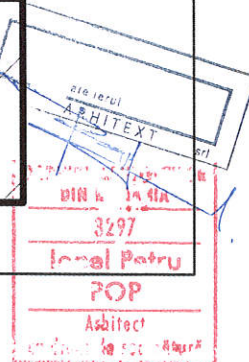
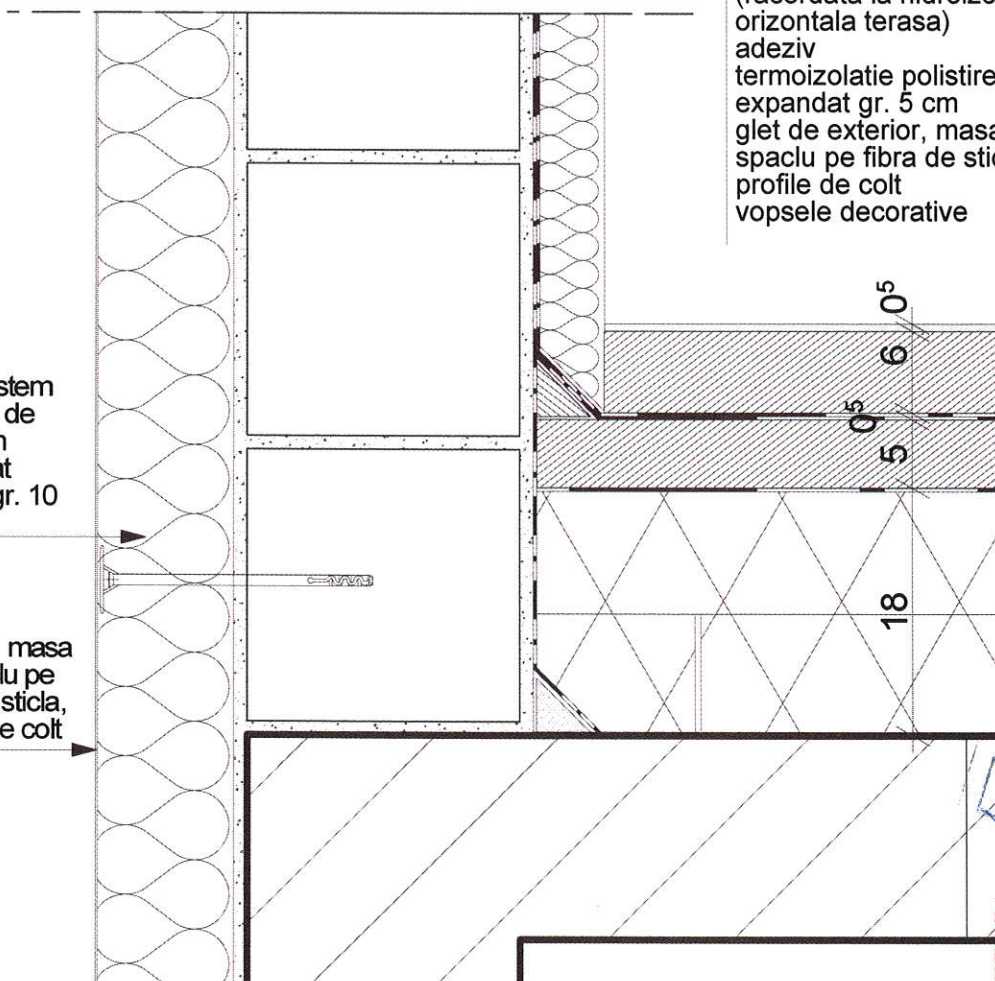

OBIECT 3
DETALII DE EXECUTIE

atelierul
ARHITEXT srl
adresa: localitatea Dumbravita, jud. Timis
Str. Mestesecanului, nr. 8

MODERNIZARE TERASE EXISTENTE,
MONTARE TERMOSISTEM LA FATADE
SI EXTINDERE PE ORIZONTALA CU
CORPURI CONSTRUCTIE D SI E IN
REGIM P+2E+Er LA SCOALA
GIMNAZIALA NR. 30

BENEFICIAR:
SCOALA GIMNAZIALA NR.30 TIMISOARA,
STRADA ASTRILOR, NR. 13, TIMISOARA

ARHITECTURA
Faza: AC, PT, DE, LC, CS

**46. FINISAJE LA ANCADRAMENTE IN CONSOLA
FATADE CORP D**

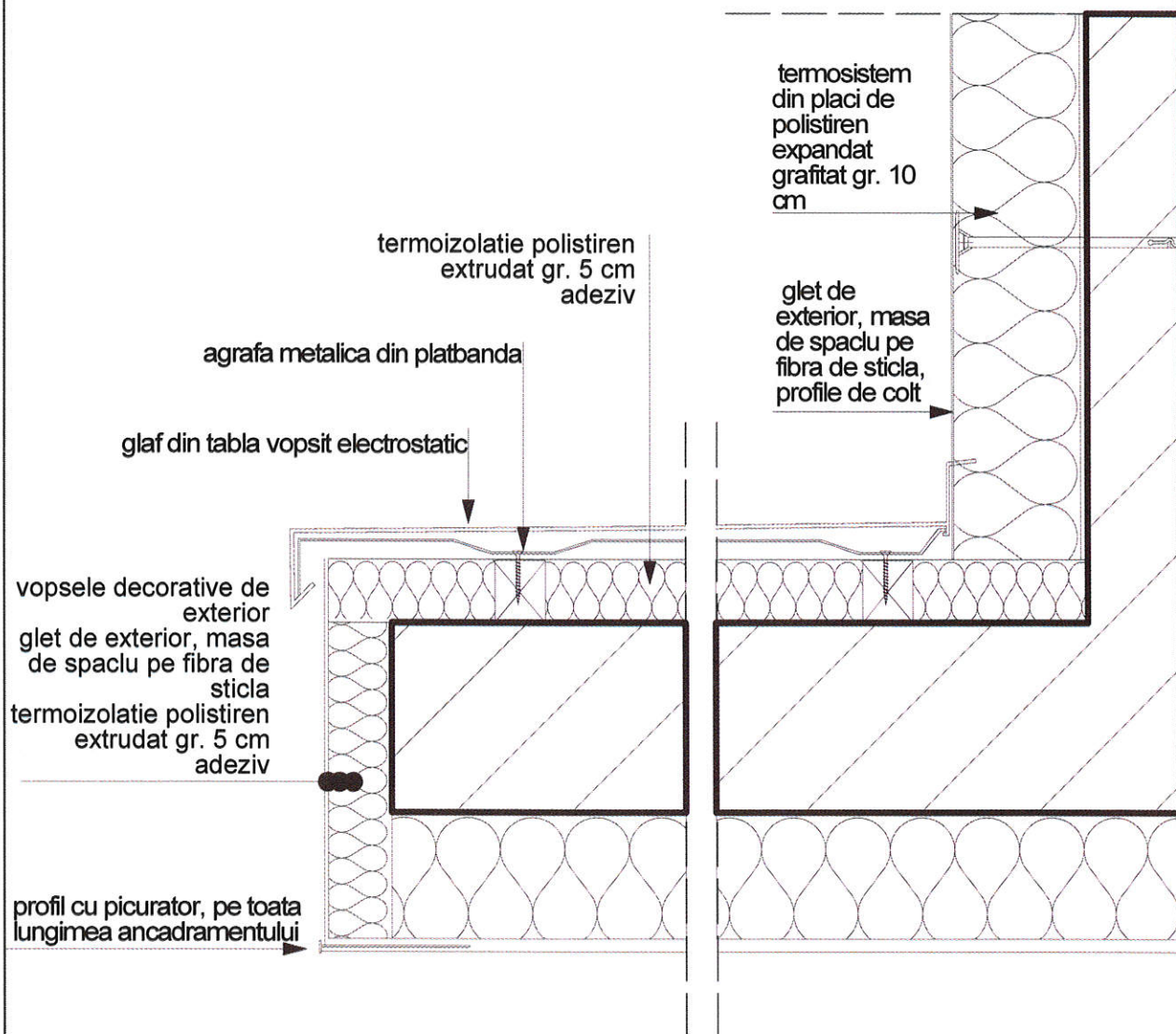

DETALIU SECTIUNE
SCARA 1:5

atelierul
ARHITEXT srl

3297
Incel Patru
TOP
Arhitect
2014.04.14

OBIECT 3

DETALII DE EXECUTIE



MODERNIZARE TERASE EXISTENTE,
MONTARE TERMOSISTEM LA FATADE
SI EXTINDERE PE ORIZONTALA CU
CORPURI CONSTRUCTIE D SI E IN
REGIM P+2E+Er LA SCOALA
GIMNAZIALA NR. 30

BENEFICIAR:
SCOALA GIMNAZIALA NR.30 TIMISOARA,
STRADA ASTRILOR, NR. 13, TIMISOARA

ARHITECTURA
Faza: AC, PT, DE, LC, CS

47. RIGOLE COLECTARE APE PLUVIALE CURTE DEMISOL ACCES TEHNIC CORP D

placi de granit natural antiderapant gr 2cm
adeziv de exterior
amorsa
hidroizolatie flexibila tip flusigfolie cu banda
de colt gr. 2 mm
amorsa
hidroizolatie membrana bituminoasa, 2
straturi gr. 8 mm
sapa slab-armata gr. 5 cm
folie PVC gr. 2 mm
placa de beton armata gr. 20 cm

rigole prefabricate carcasate din
PVC extrudur si metal
l=1m incastrate in straturile
pardoselii cu racordare
la hidroizolatie orizontale si
retea de canalizare interioara

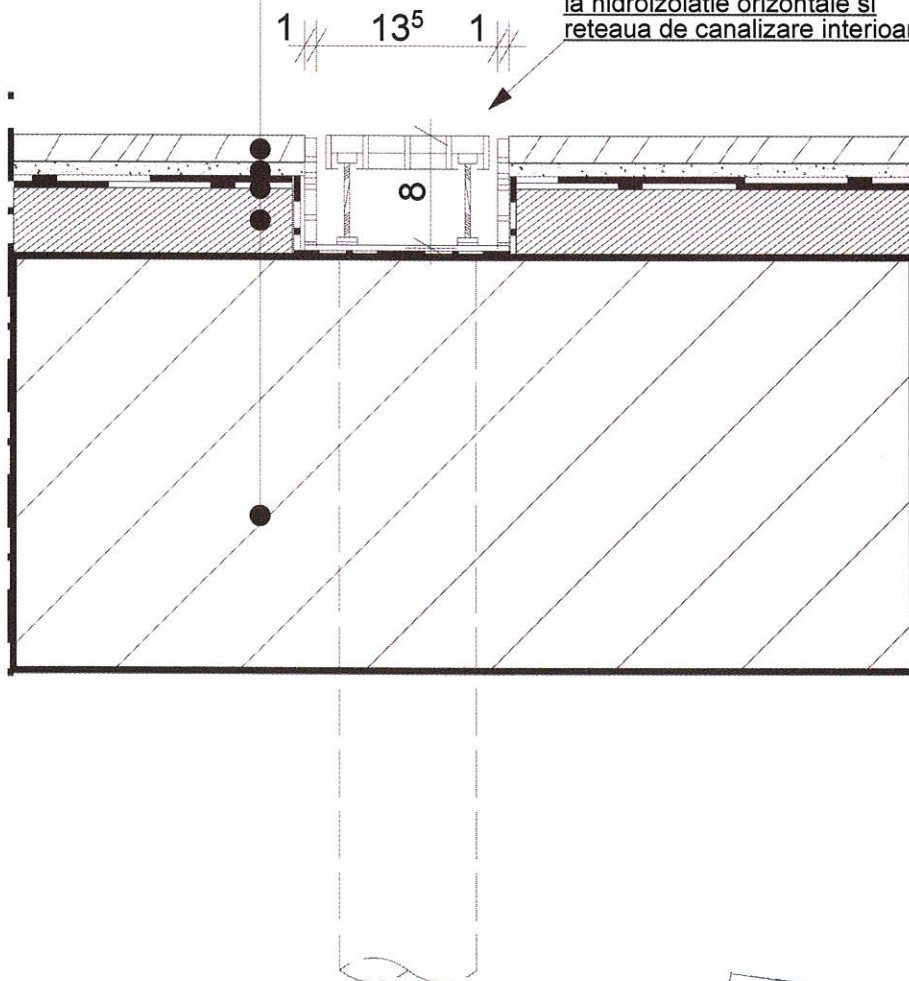

DETALIU SECTIUNE
SCARA 1:5

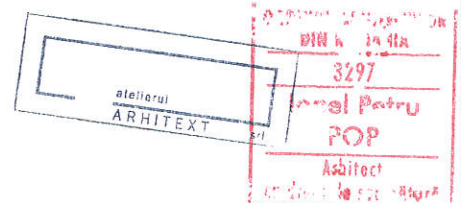

OBIECT 3
DETALII DE EXECUTIE

atelierul
ARHITEXT srl
adresa: localitatea Dumbravita, jud. Timis
Str. Mesteacanului, nr.8

MODERNIZARE TERASE EXISTENTE,
MONTARE TERMOSISTEM LA FATADE
SI EXTINDERE PE ORIZONTALA CU
CORPURI CONSTRUCTIE D SI E IN
REGIM P+2E+Er LA SCOALA
GIMNAZIALA NR. 30

BENEFICIAR:
SCOALA GIMNAZIALA NR.30 TIMISOARA,
STRADA ASTRILOR, NR. 13, TIMISOARA
ARHITECTURA
Faza: AC, PT, DE, LC, CS

48. TAMPLARII INTERIOARE CORP D

DETALIU SECTIUNE
SCARA 1:5

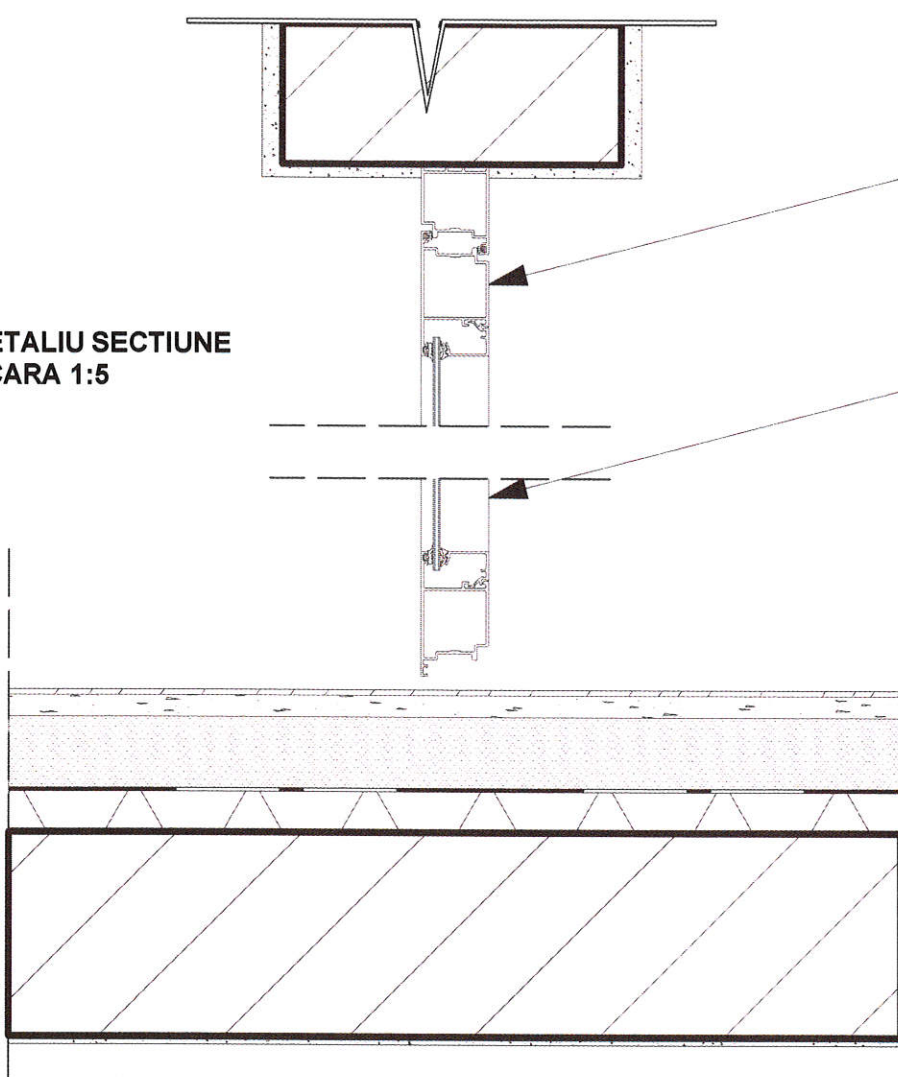

tamplarie din
aluminiu
realizata cu
garnitura de
etanseizare

geam cu sticla
3-1-3 laminata
clara



DETALIU PLAN
SCARA 1:5

tamplarie din aluminiu
realizata cu garnitura de
etanseizare

geam cu sticla
3-1-3 laminata
clara

atelierul
ARHITEXT srl

3297
Incal Petru
209
Arhitect

OBIECT 3

DETALII DE EXECUTIE



MODERNIZARE TERASE EXISTENTE,
MONTARE TERMOSISTEM LA FATADE
SI EXTINDERE PE ORIZONTALA CU
CORPURI CONSTRUCTIE D SI E IN
REGIM P+2E+Er LA SCOALA
GIMNAZIALA NR. 30

BENEFICIAR:
SCOALA GIMNAZIALA NR.30 TIMISOARA,
STRADA ASTRILOR, NR. 13, TIMISOARA

ARHITECTURA
Faza: AC, PT, DE, LC, CS

49. TAMPLARII EXTERIOARE CORP D

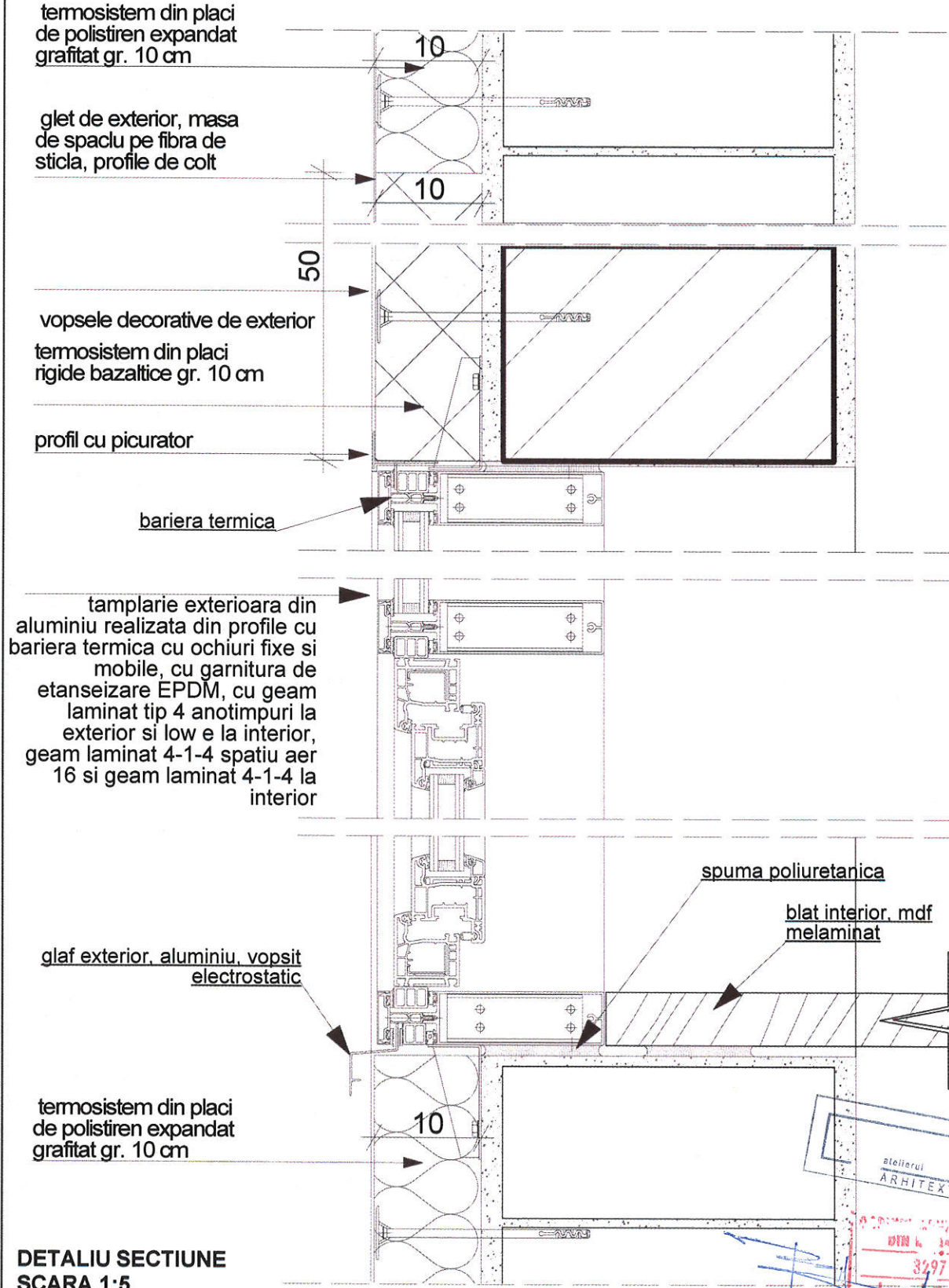

DETALIU SECTIUNE
SCARA 1:5

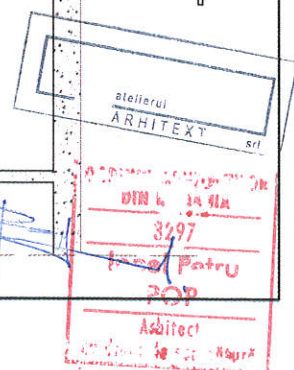

OBIECT 3

DETALII DE EXECUTIE

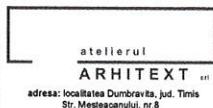

MODERNIZARE TERASE EXISTENTE,
MONTARE TERMOSISTEM LA FATADE
SI EXTINDERE PE ORIZONTALA CU
CORPURI CONSTRUCTIE D SI E IN
REGIM P+2E+Er LA SCOALA
GIMNAZIALA NR. 30

BENEFICIAR:
SCOALA GIMNAZIALA NR.30 TIMISOARA,
STRADA ASTRILOR, NR. 13, TIMISOARA

ARHITECTURA
Faza: AC, PT, DE, LC, CS

50. PROFILE DE TRECERE INTRE PARDOSELI

cover PVC gr 4 mm
adeziv
sapa autonivelanta
amorsa
sapa incalzire pardoseala, gr 6 cm
folie PVC gr. 2mm
teava incalzire in pardoseala 17mm
inglobata in izolatia polistiren
extrudat, placa cu nuturi, 3cm
termoizolatia placi polistiren extrudat
gr. 17 cm
suport, placa B.A.

placi din parchet lamelar de lemn
stratificat, gr.2cm
folie polietilena expandata, gr.
3mm
amorsa
sapa slab-armata gr 5 cm
folie PVC gr. 2mm
dala flotanta polistiren extrudat,
gr.3 cm
placa, B.A., 15 cm
finisaj interior, tencuiala

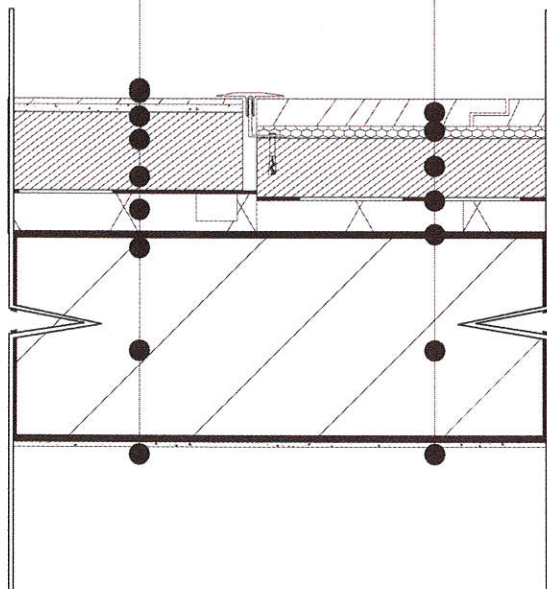

DETALIU SECTIUNE
SCARA 1:5

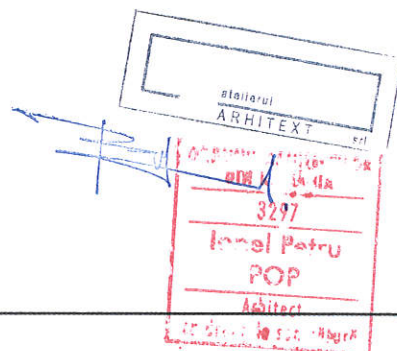

OBIECT 3

DETALII DE EXECUTIE



MODERNIZARE TERASE EXISTENTE,
MONTARE TERMOSISTEM LA FATADE
SI EXTINDERE PE ORIZONTALA CU
CORPURI CONSTRUCTIE D SI E IN
REGIM P+2+Er LA SCOALA
GIMNAZIALA NR. 30

BENEFICIAR:
SCOALA GIMNAZIALA NR.30 TIMISOARA,
STRADA ASTRILOR, NR. 13, TIMISOARA

ARHITECTURA
Faza: AC, PT, DE, LC, CS

51. PROFILE PENTRU ROSTURI DE DILATATIE LA PARDOSELI

placi de granit natural antiderapant gr. 1,5 cm
adeziv
amorsa
hidroizolatie flexibila tip flusigfolie cu banda de colt gr. 2 mm
amorsa
sapa incalzire pardoseala, gr 5 cm
folie PVC gr. 2mm
teava incalzire in pardoseala 17mm inglobata in izolatia polistiren extrudat, placa cu nuturi, 3cm
placa, B.A., 15 cm

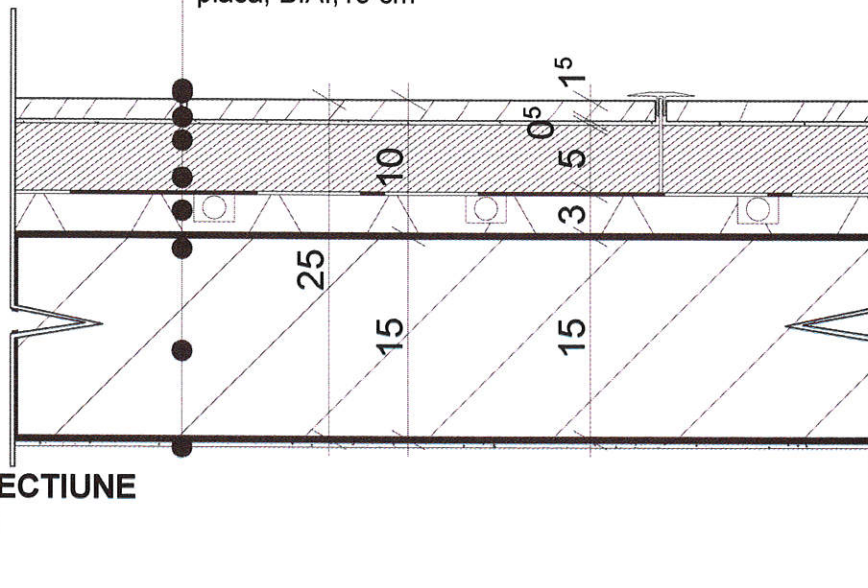

DETALIU SECTIUNE
SCARA 1:5

 - profilul, dilatat

 - profilul, comprimat

 - profilul, denivelat

- varianta perete - pardoseală

C.1

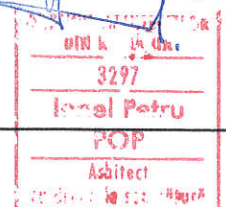

OBIECT 3

DETALII DE EXECUTIE



MODERNIZARE TERASE EXISTENTE,
MONTARE TERMOSISTEM LA FATADE
SI EXTINDERE PE ORIZONTALA CU
CORPURI CONSTRUCTIE D SI E IN
REGIM P+2E+Er LA SCOALA
GIMNAZIALA NR. 30

BENEFICIAR:
SCOALA GIMNAZIALA NR.30 TIMISOARA,
STRADA ASTRILOR, NR. 13, TIMISOARA

ARHITECTURA
Faza: AC, PT, DE, LC, CS

52. PROFILE PENTRU ROSTURI DE DILATATIE CONSTRUCTIVE



LUNGIME DILATATIE

40(+/-20) -
100(+/-50)
120(+/-60)
150(+/-75)

MATERIALE

Aluminiu
Fisa
tehnica
profil
dilatatie
seismic
pardoseala
seria
820RS

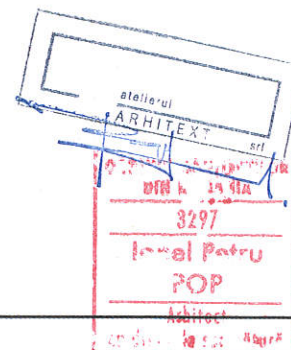

OBIECT 3
DETALII DE EXECUTIE

atelierul
ARHITEXT srl
adresa: localitatea Dumbrava, jud. Timis
Str. Mestecanului, nr.8

MODERNIZARE TERASE EXISTENTE,
MONTARE TERMOSISTEM LA FATADE
SI EXTINDERE PE ORIZZONTALA CU
CORPURI CONSTRUCTIE D SI E IN
REGIM P+2E+Er LA SCOALA
GIMNAZIALA NR. 30

BENEFICIAR:
SCOALA GIMNAZIALA NR.30 TIMISOARA,
STRADA ASTRILOR, NR. 13, TIMISOARA

ARHITECTURA
Faza: AC, PT, DE, LC, CS

53. DREN PERIMETRAL

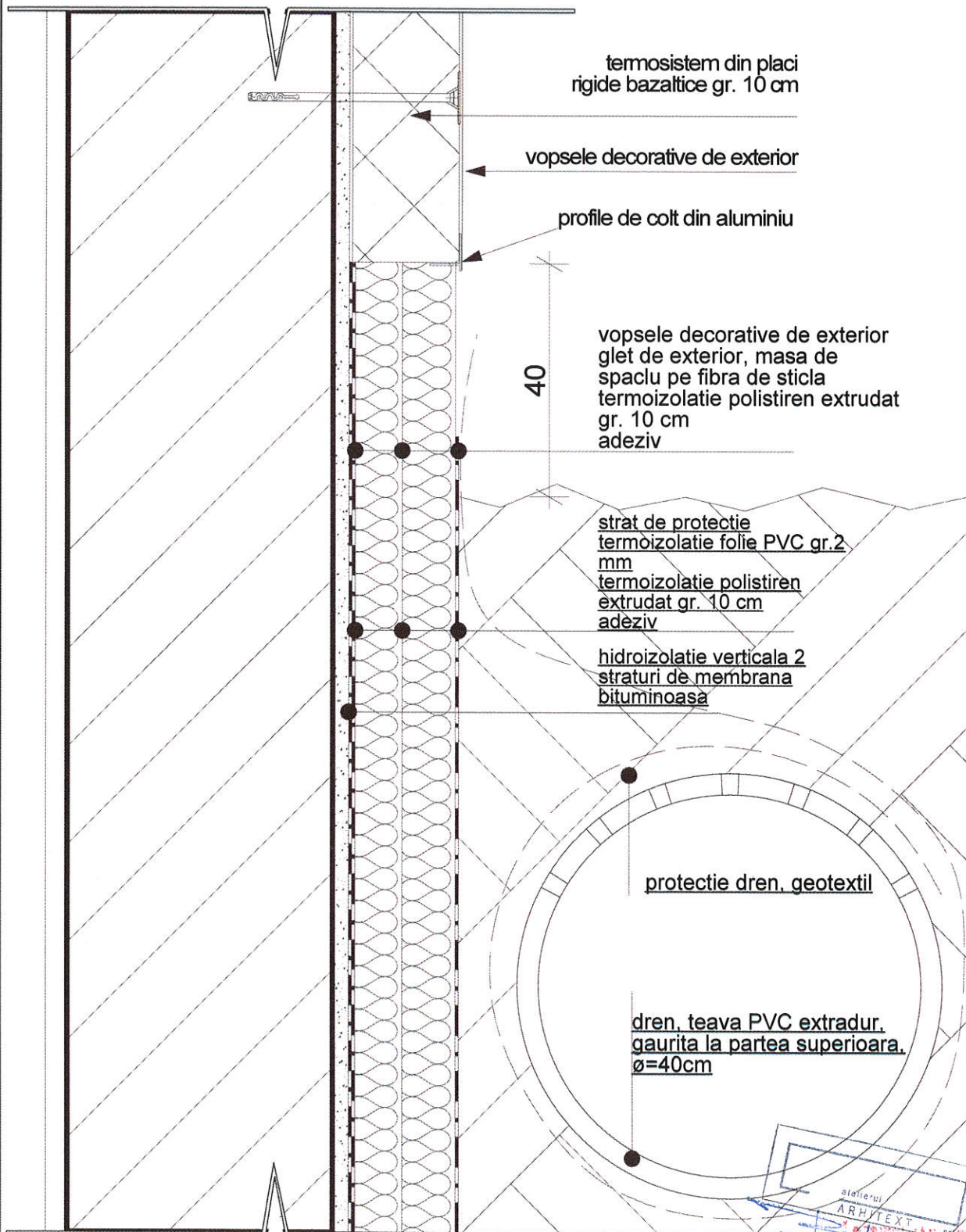

DETALIU SECTIUNE
SCARA 1:5

atelierul
ARHITEXT srl
3297
Imel Petru
POP
Arhitect

OBIECT 3
DETALII DE EXECUTIE

atelierul
ARHITEXT srl
adresa: localitatea Dumbravita, jud. Timis
Str. Mesteacanului, nr.8

MODERNIZARE TERASE EXISTENTE,
MONTARE TERMOSISTEM LA FATADE
SI EXTINDERE PE ORIZONTALA CU
CORPURI CONSTRUCTIE D SI E IN
REGIM P+2E+Er LA SCOALA
GIMNAZIALA NR. 30

BENEFICIAR:
SCOALA GIMNAZIALA NR.30 TIMISOARA,
STRADA ASTRILOR, NR. 13, TIMISOARA
ARHITECTURA
Faza: AC, PT, DE, LC, CS

54. TERMOSISTEM CONSOLA PARTER, SUB PARTER

placi de granit natural antiderapant gr 2cm
adeziv de exterior
amorsa
hidroizolatie flexibila tip flusigfolie cu banda de colt gr. 2 mm
amorsa
hidroizolatie membrana bituminoasa, 2 straturi gr. 8 mm
sapa slab-armata gr. 5 cm
folie PVC gr. 2 mm
termoizolatie polistiren extrudat gr. 10 cm
placa de beton armata gr. 20 cm

profil cu picurator, pe toata
lungimea

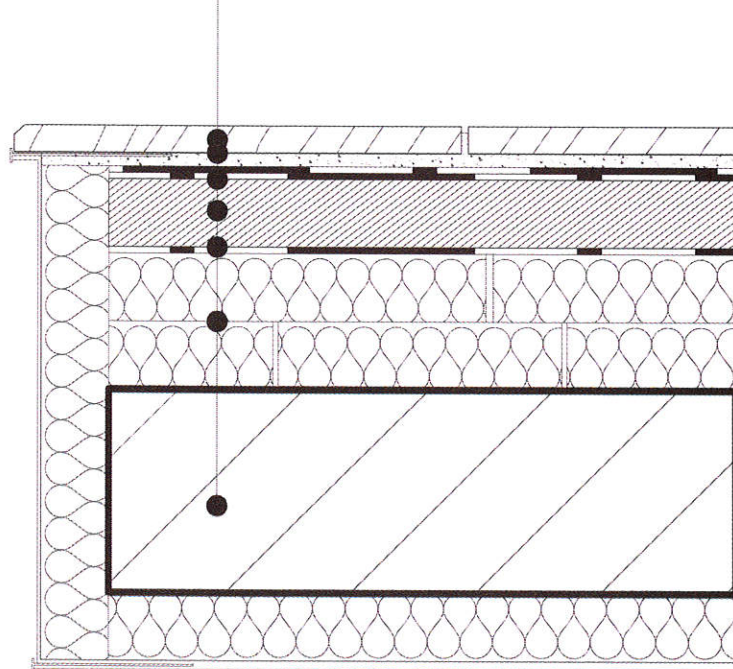

termoizolatie polistiren extrudat, 5 cm
glet de exterior, amorsa, masa de spaclu
pe plasa de fibra de sticla
vopsele decorative

DETALIU SECTIUNE
SCARA 1:5

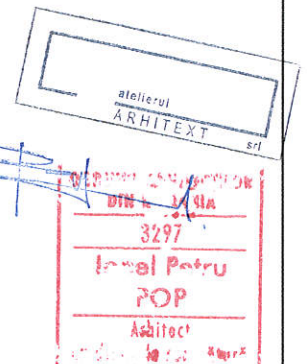

57. PERETE USOR MODULAT DE COMPARTIMENTARE SALA MULTIFUNCTIONALA

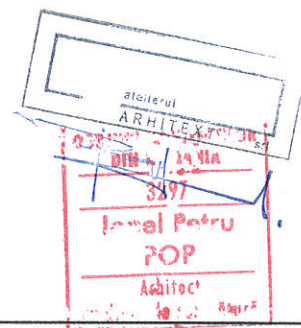
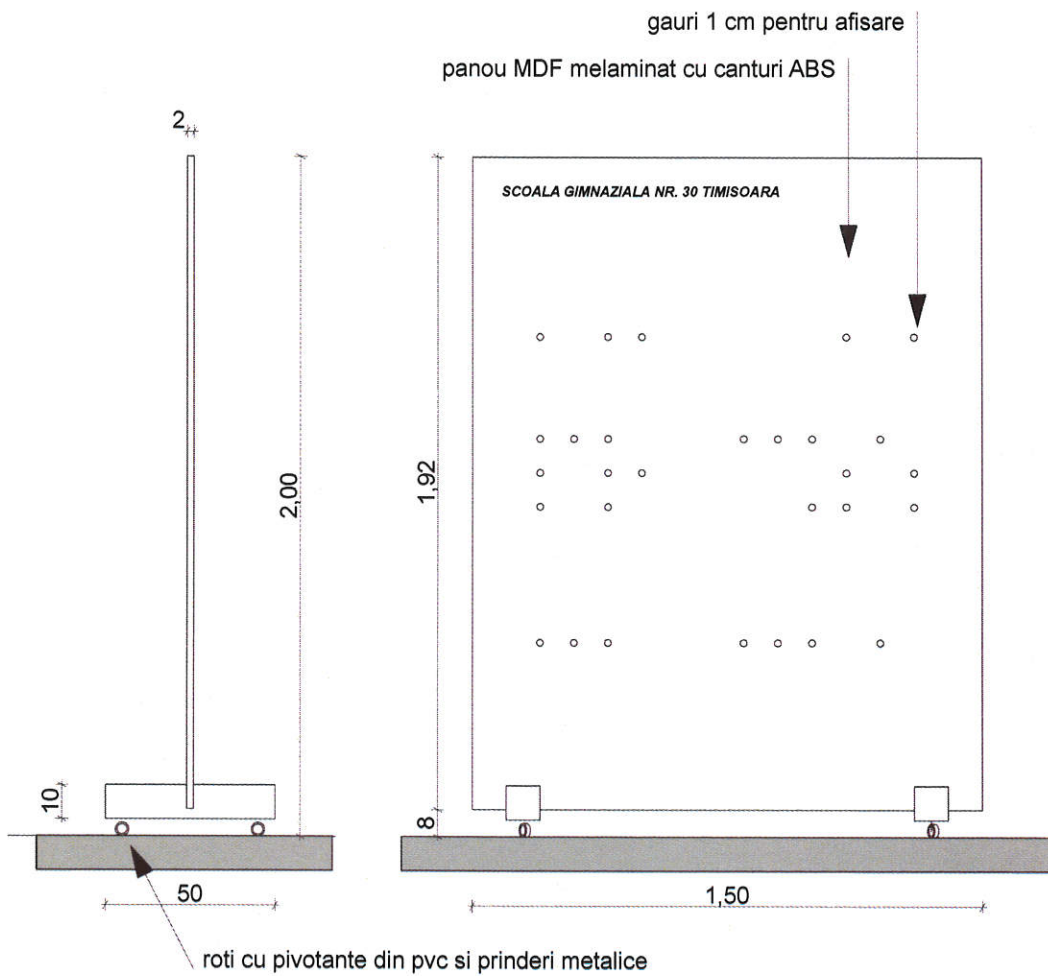

OBIECT 3
DETALII DE EXECUTIE

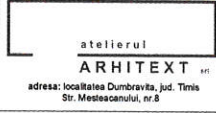

MODERNIZARE TERASE EXISTENTE,
MONTARE TERMOSISTEM LA FATADE
SI EXTINDERE PE ORIZONTALA CU
CORPURI CONSTRUCTIE D SI E IN
REGIM P+2E+Er LA SCOALA
GIMNAZIALA NR. 30

BENEFICIAR:
SCOALA GIMNAZIALA NR.30 TIMISOARA,
STRADA ASTRILOR, NR. 13, TIMISOARA

ARHITECTURA
Faza: AC, PT, DE, LC, CS

58. PASARELE DE LEGATURA CORP D cu CORP C

DETALIU SECTIUNE
SCARA 1:5

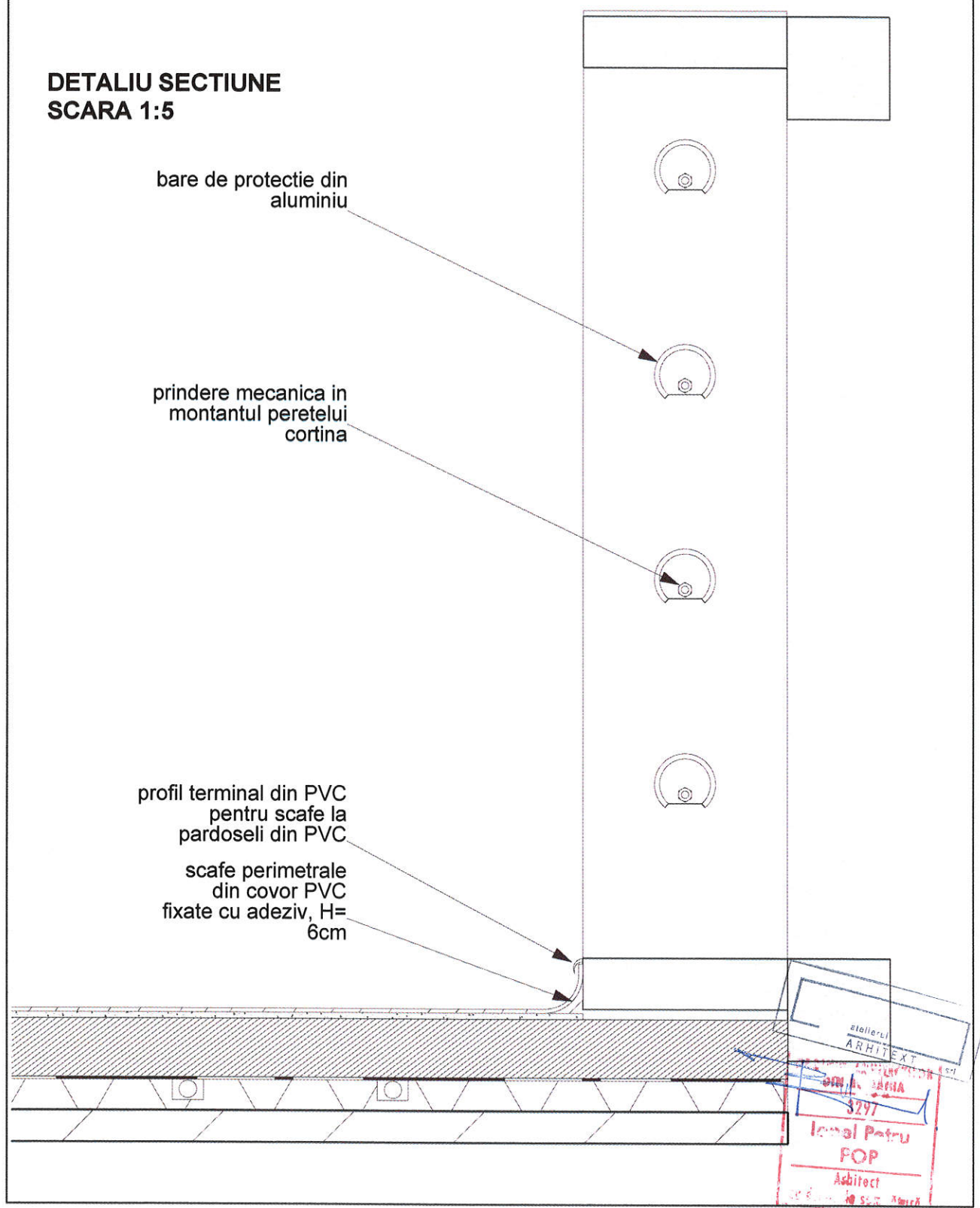

bare de protectie din aluminiu

prindere mecanica in montantul peretelui cortina

profil terminal din PVC pentru scafe la pardoseli din PVC

scafe perimetrare din cover PVC fixate cu adeziv, H=6cm

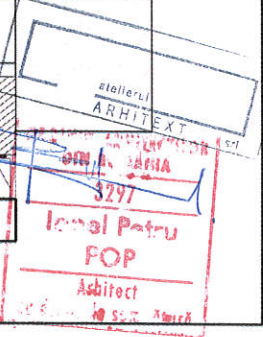

OBIECT 3

DETALII DE EXECUTIE



MODERNIZARE TERASE EXISTENTE,
MONTARE TERMOSISTEM LA FATADE
SI EXTINDERE PE ORIZONTALA CU
CORPURI CONSTRUCTIE D SI E IN
REGIM P+2E+Er LA SCOALA
GIMNAZIALA NR. 30

BENEFICIAR:
SCOALA GIMNAZIALA NR.30 TIMISOARA,
STRADA ASTRILOR, NR. 13, TIMISOARA

ARHITECTURA
Faza: AC, PT, DE, LC, CS

59. PLACAJ DECORATIV LA PERETE RECEPTIE ACCES PARTER MODEL CU TEXTURA

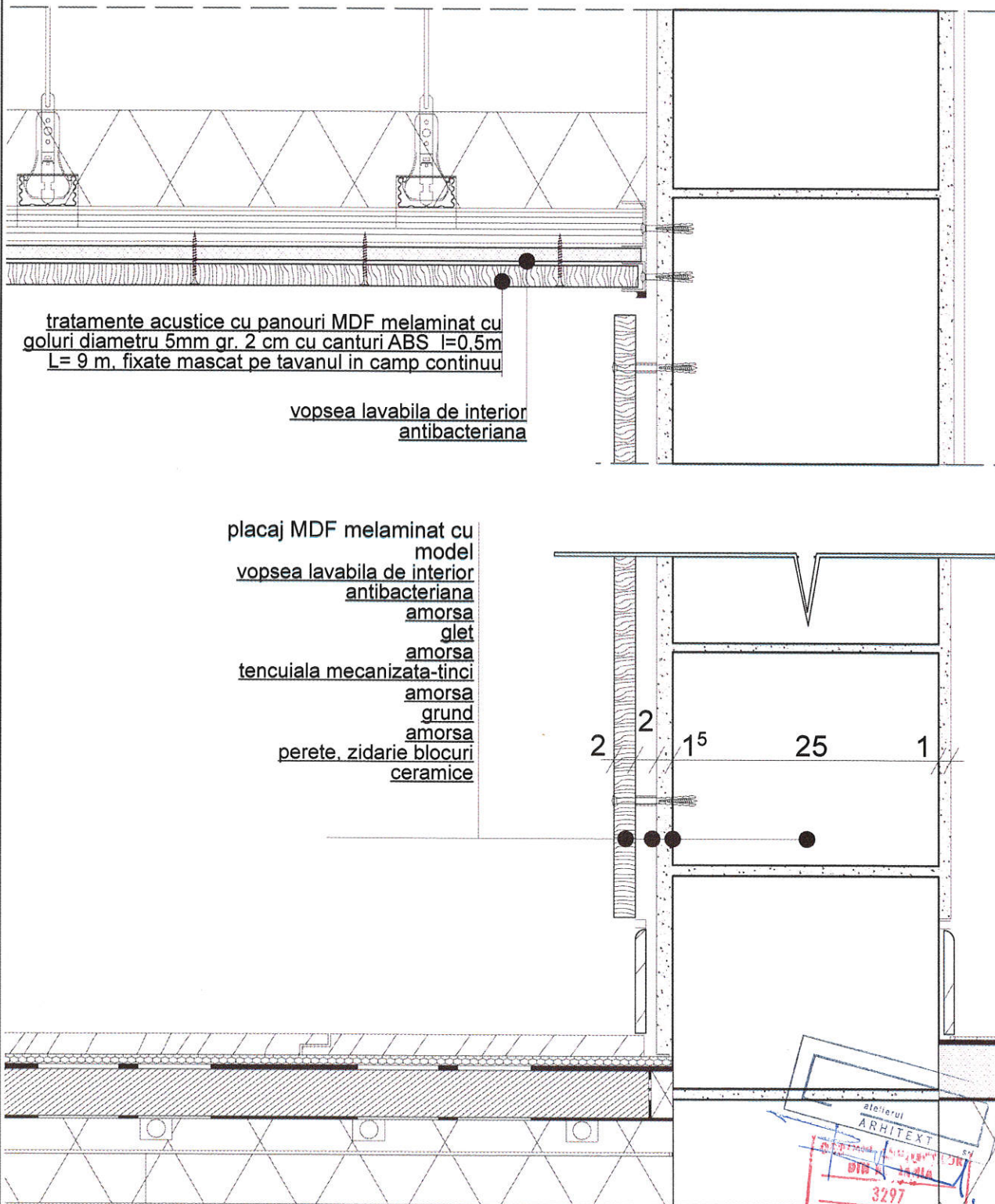

tratamente acustice cu panouri MDF melaminat cu
goluri diametru 5mm gr. 2 cm cu canturi ABS l=0,5m
L= 9 m, fixate mascat pe tavanul in camp continuu

vopsea lavabila de interior
antibacteriana

placaj MDF melaminat cu
model
vopsea lavabila de interior
antibacteriana
amorsa
glet
amorsa
tencuiala mecanizata-tinci
amorsa
grund
amorsa
perete, zidarie blocuri
ceramice

DETALIU SECTIUNE
SCARA 1:5

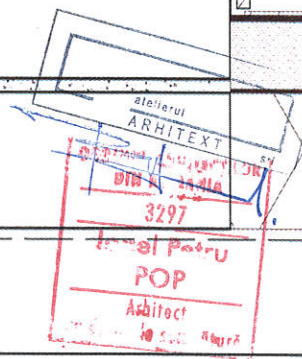

OBIECT 3

DETALII DE EXECUTIE

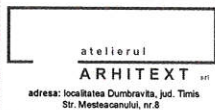

MODERNIZARE TERASE EXISTENTE,
MONTARE TERMOSISTEM LA FATADE
SI EXTINDERE PE ORIZONTALA CU
CORPURI CONSTRUCTIE D SI E IN
REGIM P+2E+Er LA SCOALA
GIMNAZIALA NR. 30

BENEFICIAR:
SCOALA GIMNAZIALA NR.30 TIMISOARA,
STRADA ASTRILOR, NR. 13, TIMISOARA

ARHITECTURA
Faza: AC, PT, DE, LC, CS

60. GLAFURI INTERIOARE LA FERESTRE

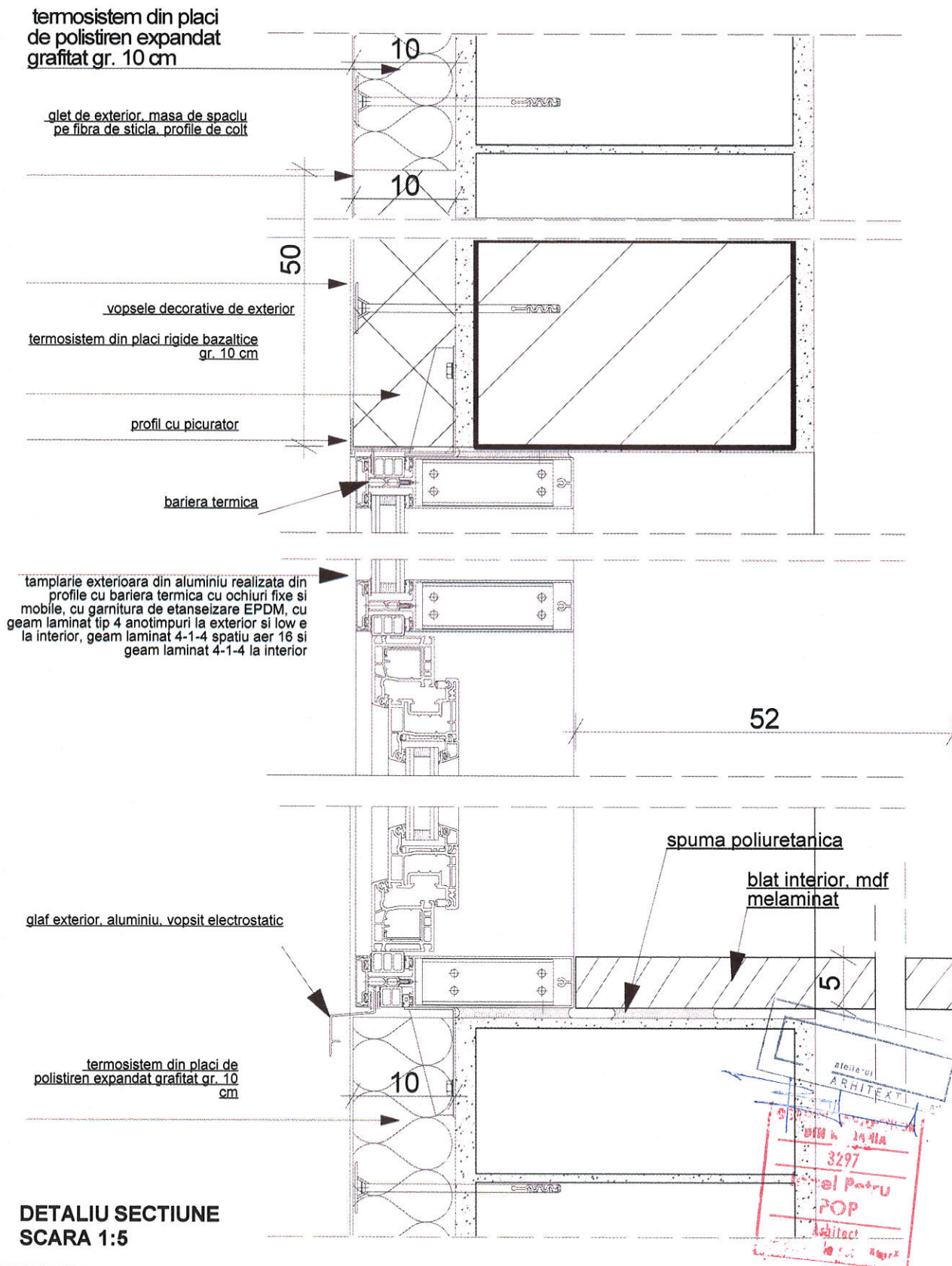

OBIECT 3

DETALII DE EXECUTIE



MODERNIZARE TERASE EXISTENTE,
MONTARE TERMOSISTEM LA FATADE
SI EXTINDERE PE ORIZONTALA CU
CORPURI CONSTRUCTIE D SI E IN
REGIM P+2E+Er LA SCOALA
GIMNAZIALA NR. 30

BENEFICIAR:
SCOALA GIMNAZIALA NR.30 TIMISOARA,
STRADA ASTRILOR, NR. 13, TIMISOARA

ARHITECTURA
Faza: AC, PT, DE, LC, CS

61. GLAFURI EXTERIOARE LA FERESTRE

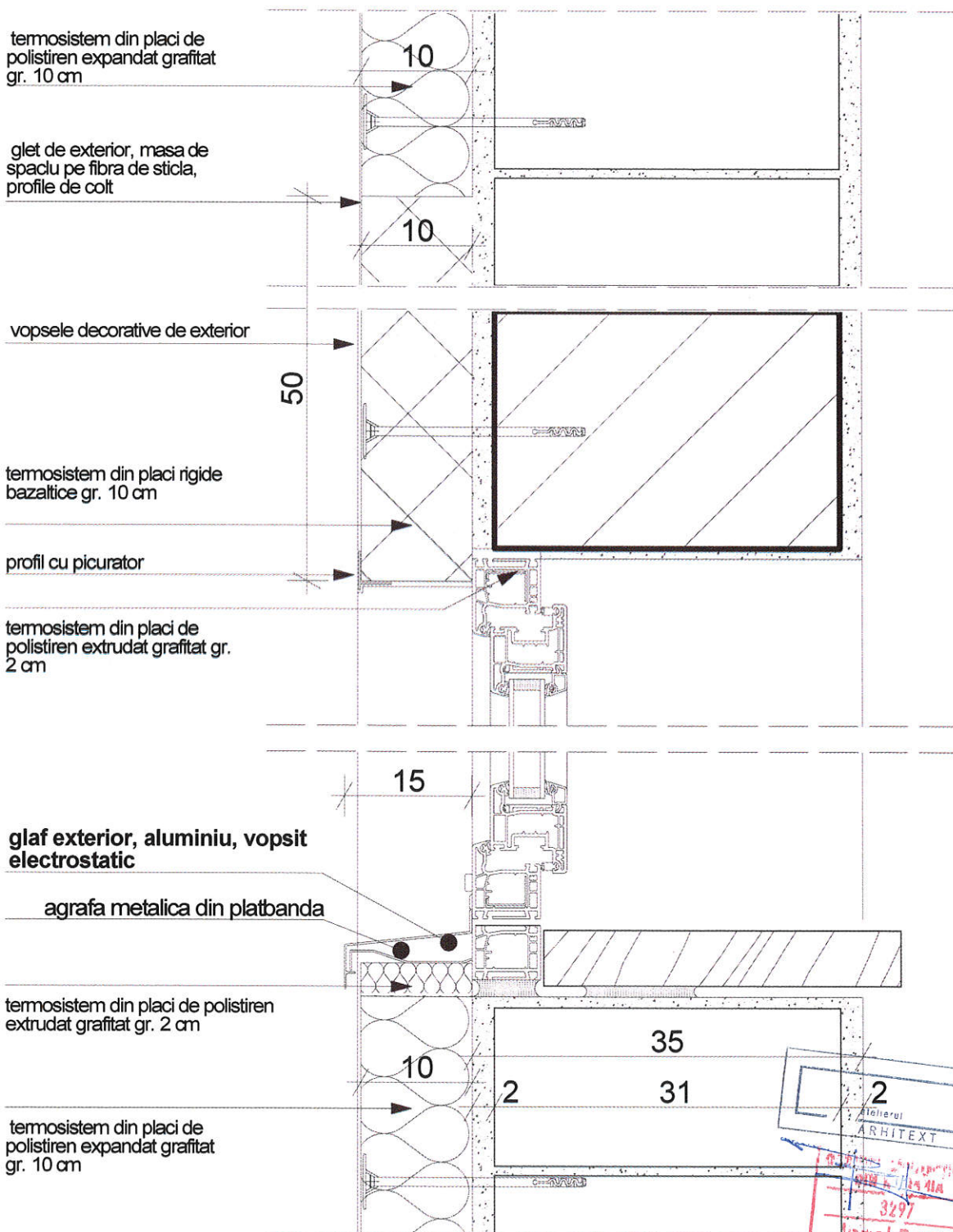

DETALIU SECTIUNE
SCARA 1:5



OBIECT 3

DETALII DE EXECUTIE

atelierul
ARHITEXT srl
adresa: localitatea Dumbravita, jud. Timis
Str. Mesteacanului, nr.8

MODERNIZARE TERASE EXISTENTE,
MONTARE TERMOSISTEM LA FATADE
SI EXTINDERE PE ORIZONTALA CU
CORPURI CONSTRUCTIE D SI E IN
REGIM P+2E+Er LA SCOALA
GIMNAZIALA NR. 30

BENEFICIAR:
SCOALA GIMNAZIALA NR.30 TIMISOARA,
STRADA ASTRILOR, NR. 13, TIMISOARA

ARHITECTURA
Faza: AC, PT, DE, LC, CS

62. SCARA METALICA ACCES TERASA INTRE CORP

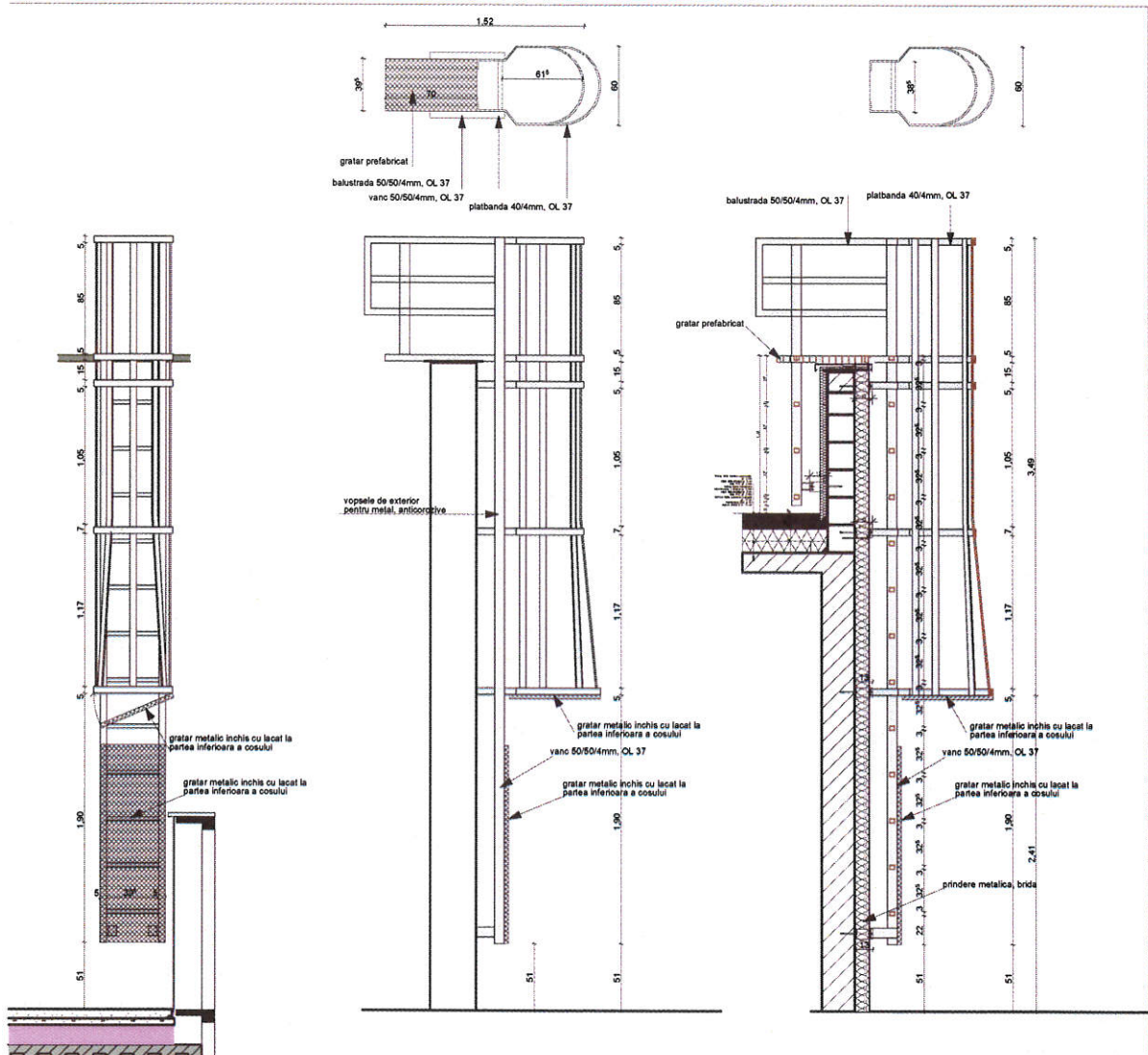

atelierul
ARHITEXT srl

3297
Anul Patru
POP
Asbitoc

OBIECT 3

DETALII DE EXECUTIE



MODERNIZARE TERASE EXISTENTE,
MONTARE TERMOSISTEM LA FATADE
SI EXTINDERE PE ORIZONTALA CU
CORPURI CONSTRUCTIE D SI E IN
REGIM P+2E+Er LA SCOALA
GIMNAZIALA NR. 30

BENEFICIAR:
SCOALA GIMNAZIALA NR.30 TIMISOARA,
STRADA ASTRILOR, NR. 13, TIMISOARA

ARHITECTURA
Faza: AC, PT, DE, LC, CS

63. COPERTINA USA ACCES TERASA

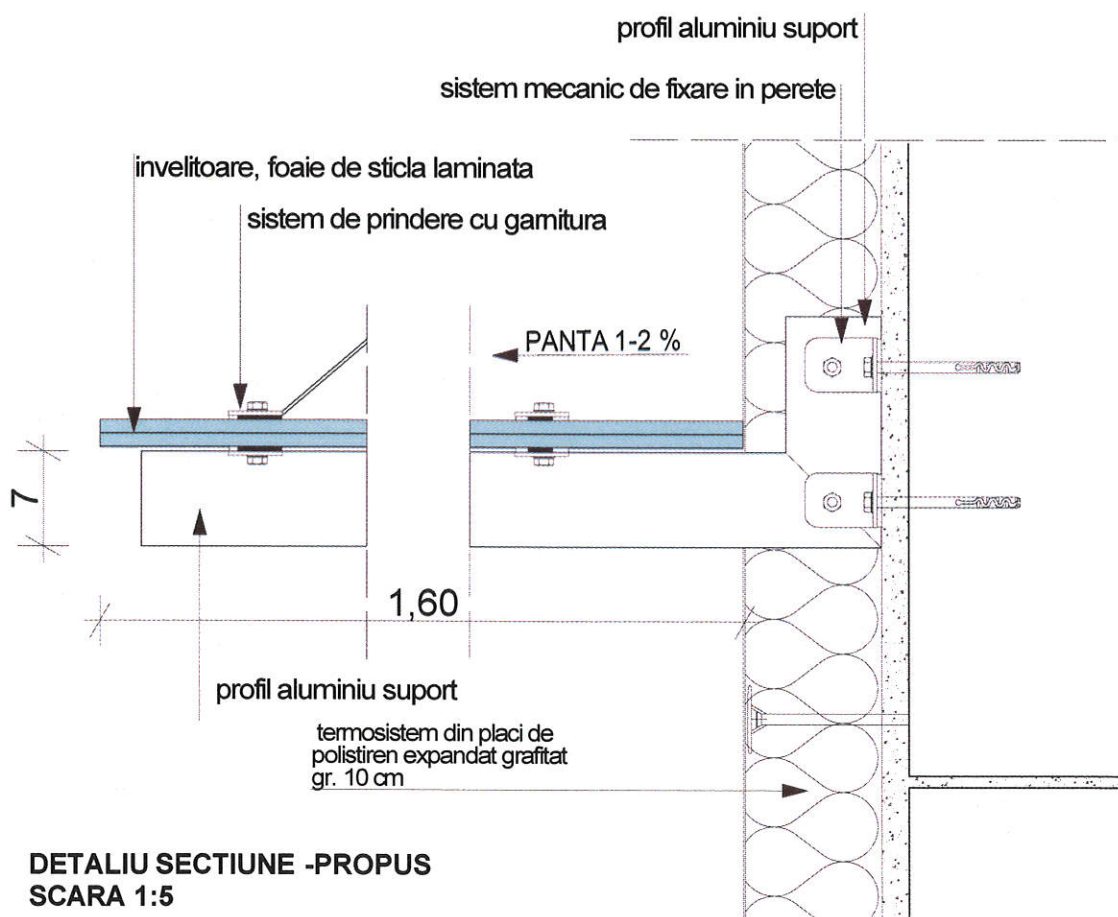

DETALIU SECTIUNE -PROPUS
SCARA 1:5

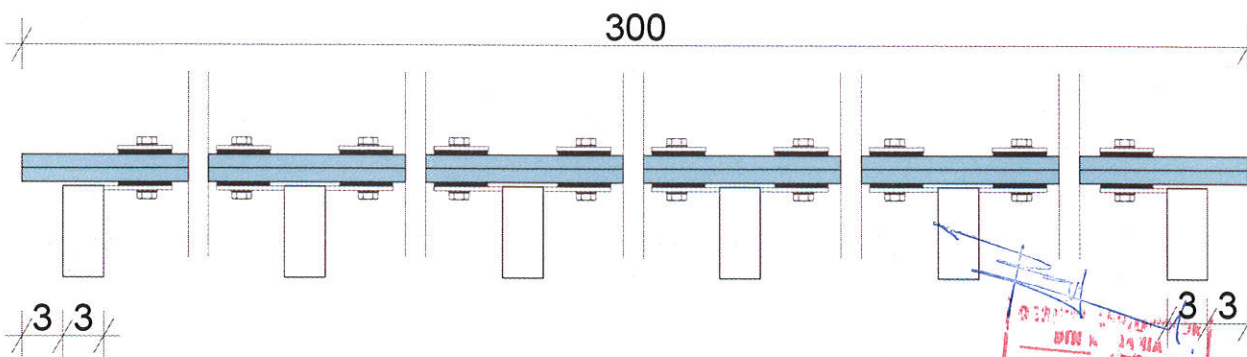

DETALIU SECTIUNE
SCARA 1:5

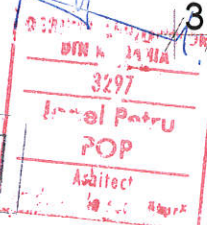

OBIECT 3
DETALII DE EXECUTIE

stelierul
ARHITEXT srl
adresa: localitatea Dumbravita, jud. Timis
Str. Mesteacanului, nr.8

**MODERNIZARE TERASE EXISTENTE,
MONTARE TERMOSISTEM LA FATADE
SI EXTINDERE PE ORIZONTALA CU
CORPURI CONSTRUCTIE D SI E IN
REGIM P+2E+Er LA SCOALA
GIMNAZIALA NR. 30**

BENEFICIAR:
SCOALA GIMNAZIALA NR.30 TIMISOARA,
STRADA ASTRILOR, NR. 13, TIMISOARA
ARHITECTURA
Faza: AC, PT, DE, LC, CS

64. IMPREJMUIRE METALICA

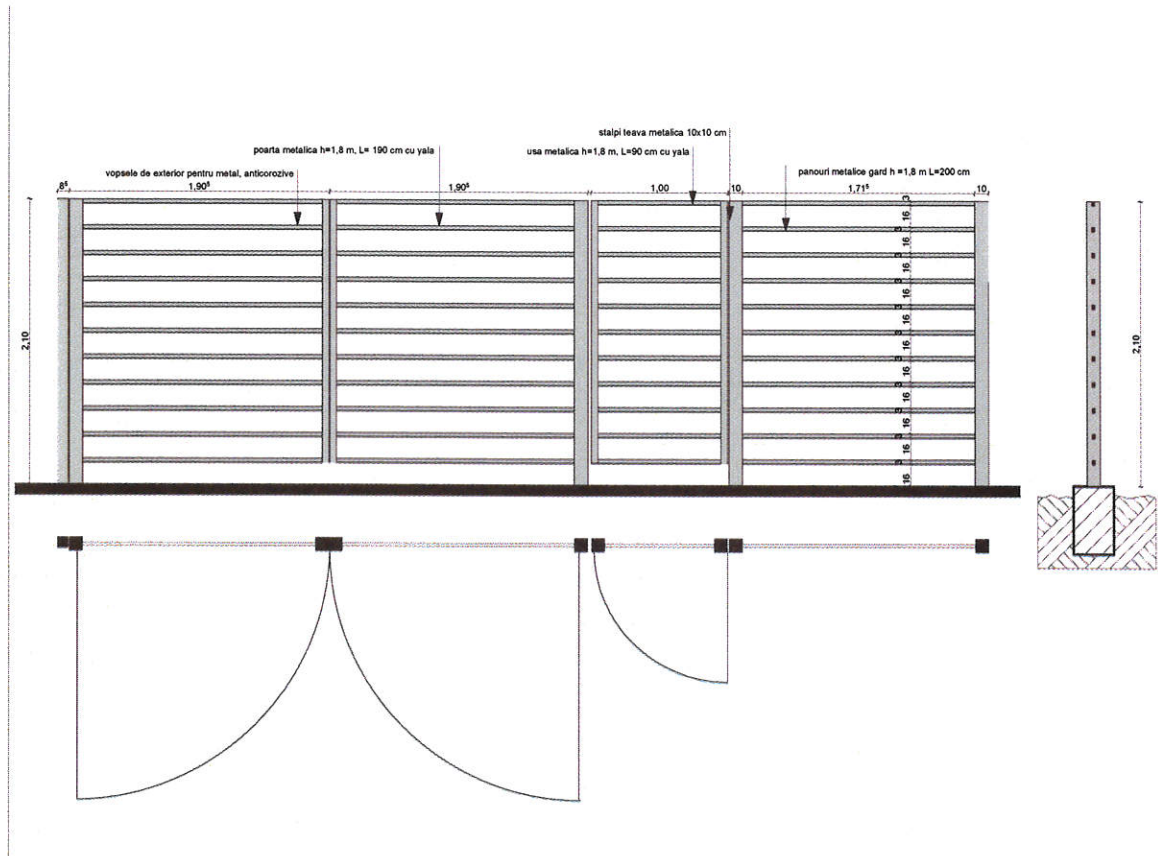

stelierul
ARHITEXT srl

3297
Iosif Patru
POP
Arhitect

OBIECT 3

DETALII DE EXECUTIE

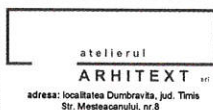

MODERNIZARE TERASE EXISTENTE,
MONTARE TERMOSISTEM LA FATADE
SI EXTINDERE PE ORIZONTALA CU
CORPURI CONSTRUCTIE D SI E IN
REGIM P+2E+Er LA SCOALA
GIMNAZIALA NR. 30

BENEFICIAR:
SCOALA GIMNAZIALA NR.30 TIMISOARA,
STRADA ASTRILOR, NR. 13, TIMISOARA

ARHITECTURA
Faza: AC, PT, DE, LC, CS

65. TRAPA AUTOMATA DE EVACUARE FUM IN CASA SCARII 100 cm x100 cm

1. strat dublu de sticlă acrilică (PMMA)
2. cadru din aluminiu pentru fixarea straturilor de PMMA
3. balama NIRO
4. guler metalic (AlMg3 cu 2,5 mm grosime) pentru o mai bună etanseizare
5. soclu, tip N, din otel zincat cu grosimea de 2 mm, vopsit la exterior RAL 9002, termoizolat cu vată minerală (3 cm grosime)
6. termoizolație

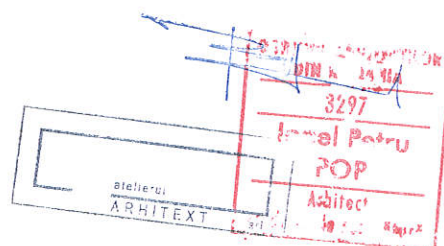
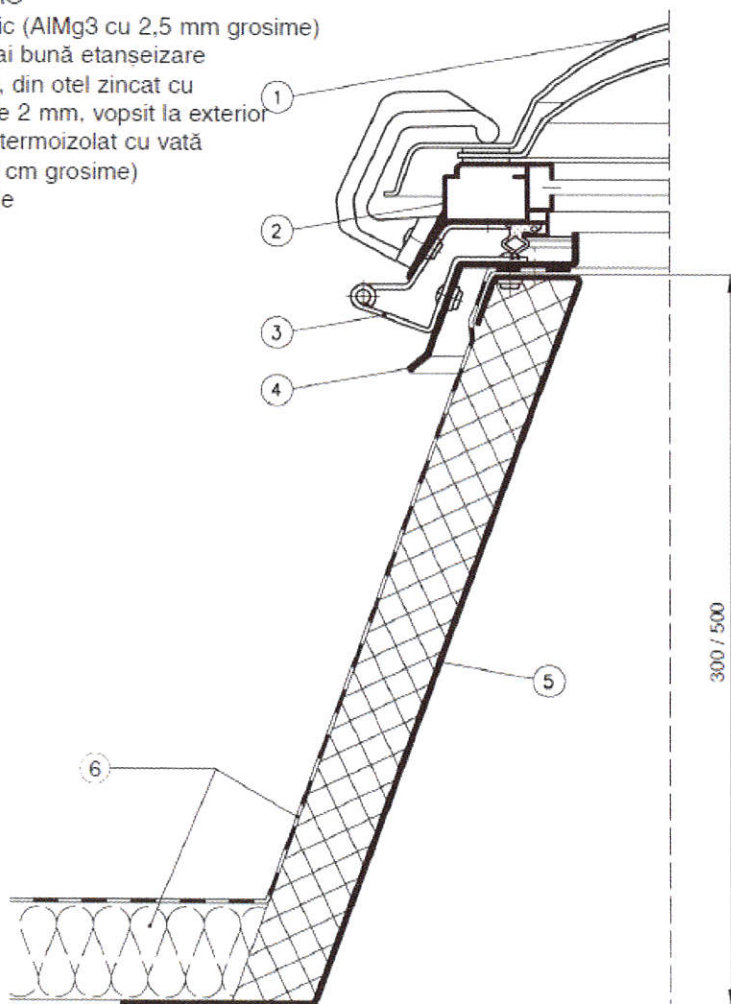

OBIECT 4

DETALII DE EXECUTIE



MODERNIZARE TERASE EXISTENTE,
MONTARE TERMOSISTEM LA FATADE
SI EXTINDERE PE ORIZONTALA CU
CORPURI CONSTRUCTIE D SI E IN
REGIM P+2E+Er LA SCOALA
GIMNAZIALA NR. 30

BENEFICIAR:
SCOALA GIMNAZIALA NR.30 TIMISOARA,
STRADA ASTRILOR, NR. 13, TIMISOARA

ARHITECTURA
Faza: AC, PT, DE, LC, CS

1. DEMOLARE PLATFORMA BETONATA EXISTENTA SI SCARA ACCES DEMISOL

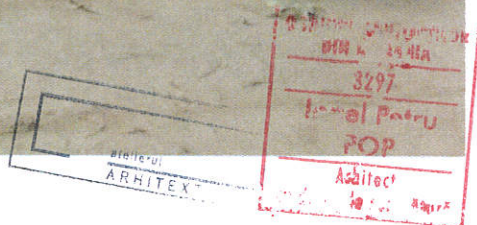

OBIECT 4

DETALII DE EXECUTIE



MODERNIZARE TERASE EXISTENTE,
MONTARE TERMOSISTEM LA FATADE
SI EXTINDERE PE ORIZONTALA CU
CORPURI CONSTRUCTIE D SI E IN
REGIM P+2+Er LA SCOALA
GIMNAZIALA NR. 30

BENEFICIAR:
SCOALA GIMNAZIALA NR.30 TIMISOARA,
STRADA ASTRILOR, NR. 13, TIMISOARA

ARHITECTURA
Faza: AC, PT, DE, LC, CS

2. PARDOSEALA TROTUARE EXTERIOARE PERIMETRALE

materiale : placi de granit natural antiderapant gr 2 cm
adeziv de exterior
amorsa
sapa de panta slab-armata gr. 5 cm
placa de beton slab-armata gr. 20 cm
folie PVC gr. 2 mm
strat pietris compactat gr. 20 cm
strat geotextil
strat piatra sparta compactata gr. 20 cm

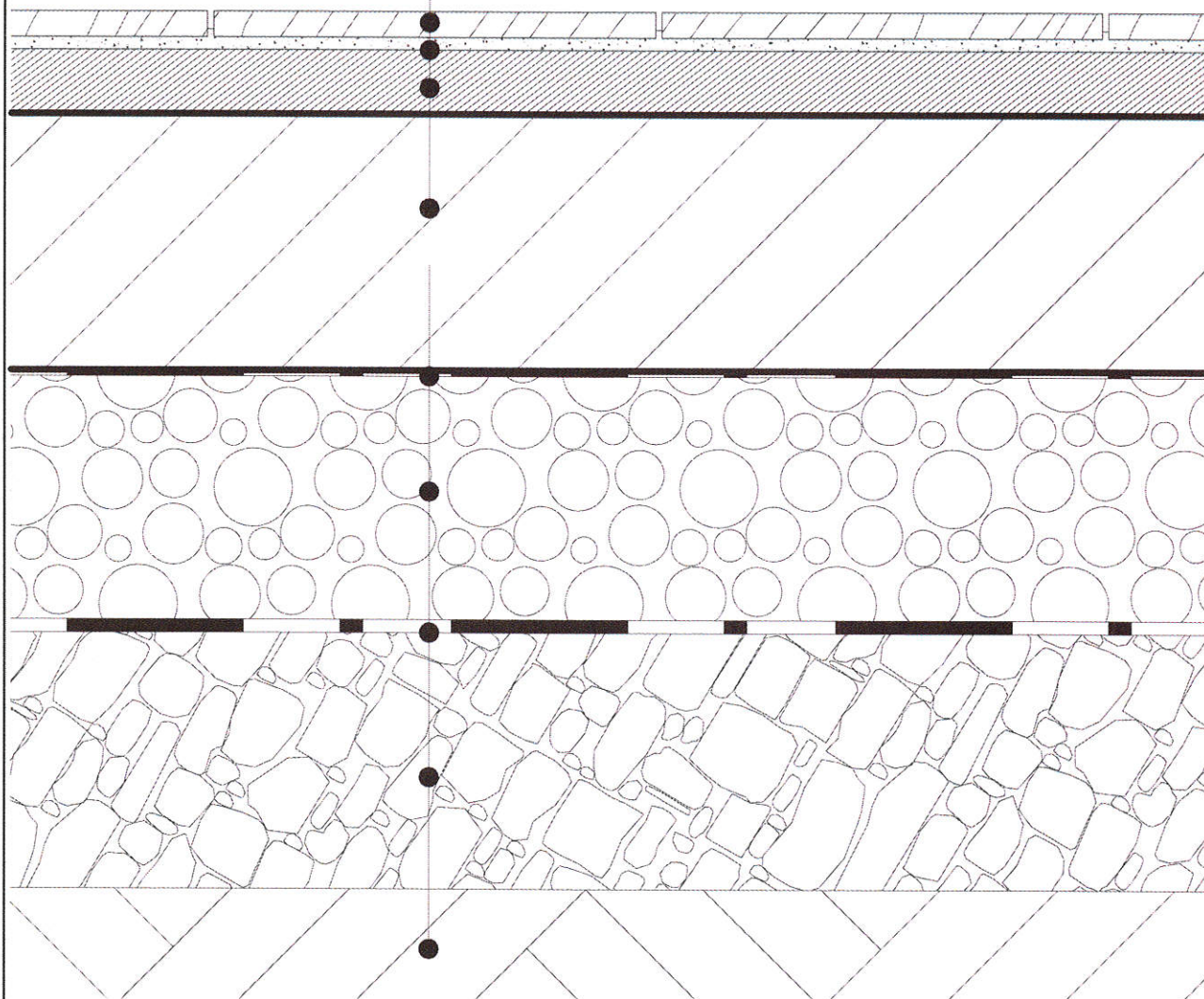

DETALIU SECTIUNE
SCARA 1:5



OBIECT 4

DETALII DE EXECUTIE



MODERNIZARE TERASE EXISTENTE,
MONTARE TERMOSISTEM LA FATADE
SI EXTINDERE PE ORIZONTALA CU
CORPURI CONSTRUCTIE D SI E IN
REGIM P+2E+Er LA SCOALA
GIMNAZIALA NR. 30

BENEFICIAR:
SCOALA GIMNAZIALA NR.30 TIMISOARA,
STRADA ASTRILOR, NR. 13, TIMISOARA

ARHITECTURA
Faza: AC, PT, DE, LC, CS

3. PARDOSELI INTERIOARE DIN PLACI DE GRANIT NATURAL ANTIDERAPANT SI PLINTE CASELE DE SCARA DEMISOL CORP D

placi de granit natural antiderapant gr 1,5 cm
adeziv, amorsa
hidroizolatie flexibila tip flusigfolie cu banda de colt gr. 2 mm
amorsa
sapa incalzire pardoseala, gr 5 cm
folie PVC gr. 2mm
termoizolatie, polistiren extrudat, gr. 3cm
radier general, B.A., 70 cm
protectie, sapa de ciment, 5 cm
HIZ, membrana bituminoasa, 2x0,5 cm
egalizare, beton C 8/10, 10 cm
piatra sparta compactata, 50cm
teren natural

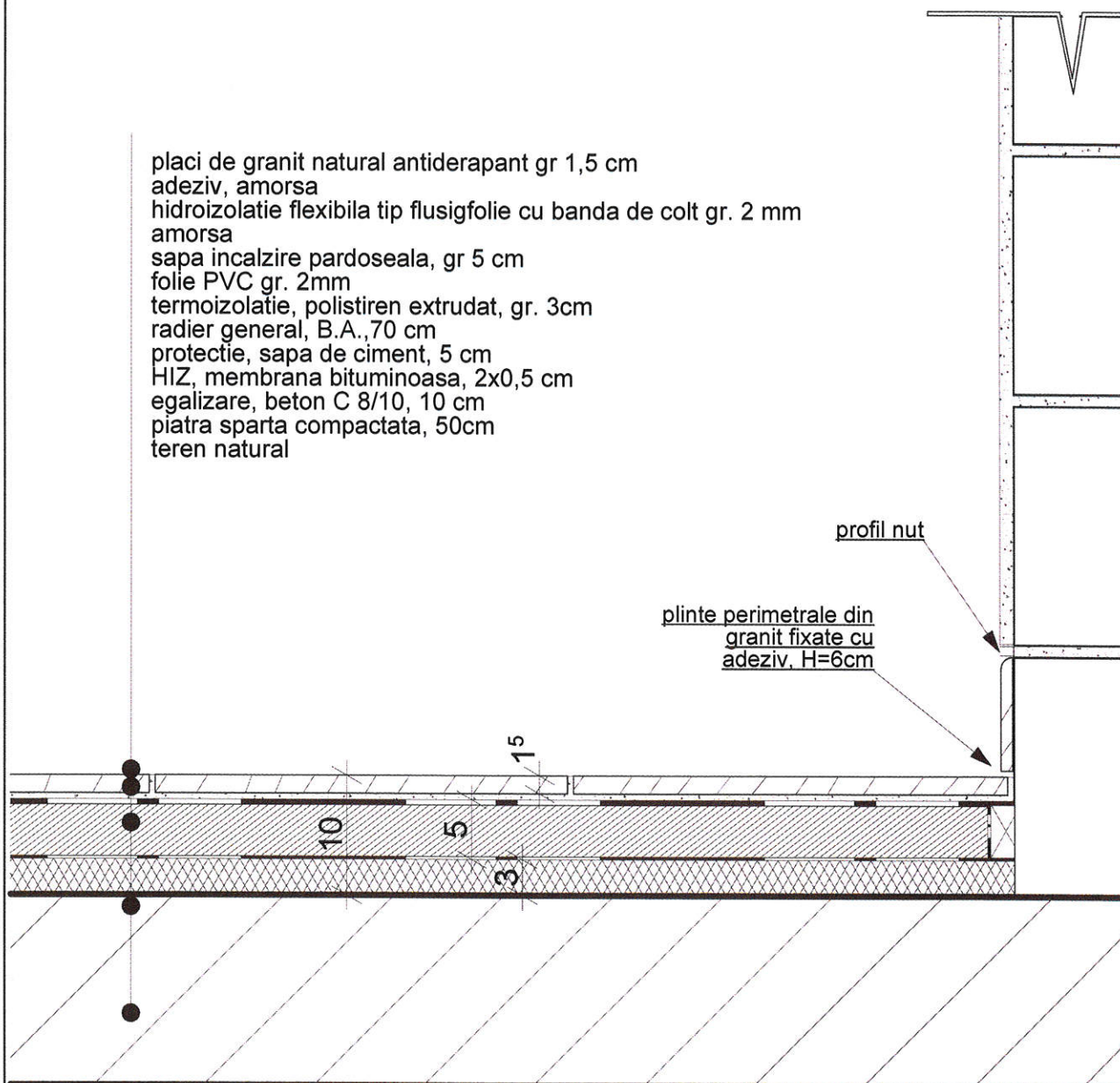

DETALIU SECTIUNE
SCARA 1:5



OBIECT 4

DETALII DE EXECUTIE

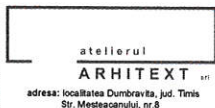

MODERNIZARE TERASE EXISTENTE,
MONTARE TERMOSISTEM LA FATADE
SI EXTINDERE PE ORIZONTALA CU
CORPURI CONSTRUCTIE D SI E IN
REGIM P+2E+Er LA SCOALA
GIMNAZIALA NR. 30

BENEFICIAR:
SCOALA GIMNAZIALA NR.30 TIMISOARA,
STRADA ASTRILOR, NR. 13, TIMISOARA

ARHITECTURA
Faza: AC, PT, DE, LC, CS

4. PARDOSELI INTERIOARE DIN PLACI DE GRANIT NATURAL ANTIDERAPANT SI PLINTE CASELE DE SCARA ET. 1, ET. 2 - CORP E

placi de granit natural antiderapant gr 1,5 cm
adeziv, amorsa
hidroizolatie flexibila tip flusigfolie cu banda de colt gr. 2 mm
amorsa
sapa incalzire pardoseala, gr 5 cm
folie PVC gr. 2mm
teava incalzire in pardoseala 17mm inglobata in izolatie
polistiren extrudat, placa cu nuturi, 3cm
radiere general, B.A., 70 cm
protectie, sapa de ciment, 5 cm
HIZ, membrana bituminoasa, 2x0,5 cm
egalizare, beton C 8/10, 10 cm
piatra sparta compactata, 50cm
teren natural

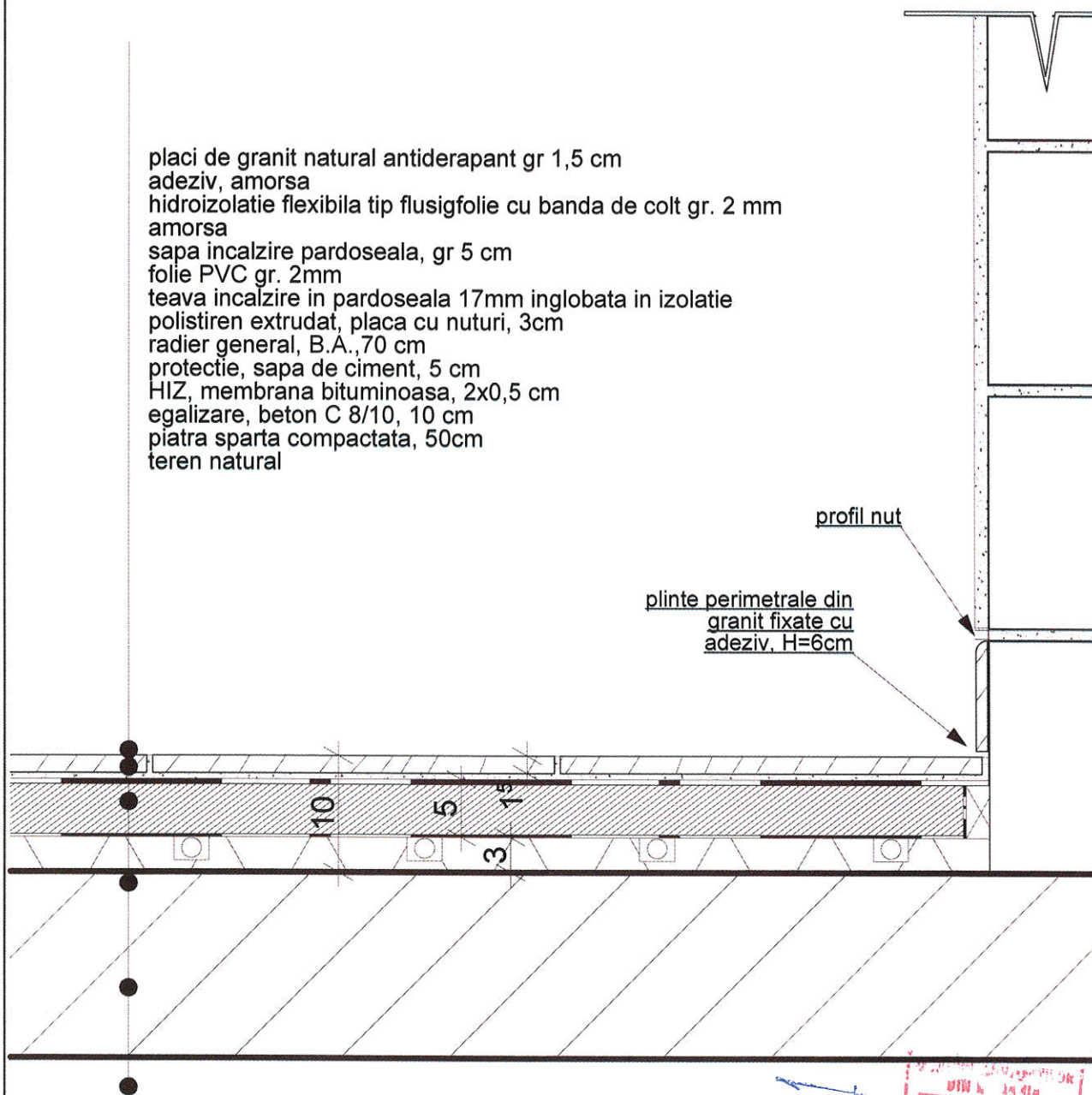

profil nut

plințe perimetrare din
granit fixate cu
adeziv, H=6cm

DETALIU SECTIUNE
SCARA 1:5

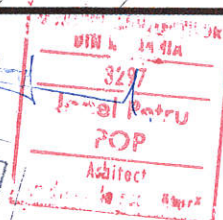

OBIECT 4

DETALII DE EXECUTIE



MODERNIZARE TERASE EXISTENTE,
MONTARE TERMOSISTEM LA FATADE
SI EXTINDERE PE ORIZONTALA CU
CORPURI CONSTRUCTIE D SI E IN
REGIM P+2+E+R LA SCOALA
GIMNAZIALA NR. 30

BENEFICIAR:
SCOALA GIMNAZIALA NR.30 TIMISOARA,
STRADA ASTRILOR, NR. 13, TIMISOARA

ARHITECTURA
Faza: AC, PT, DE, LC, CS

5. PLACARI SCARI INTERIOARE DIN BETON CORP E

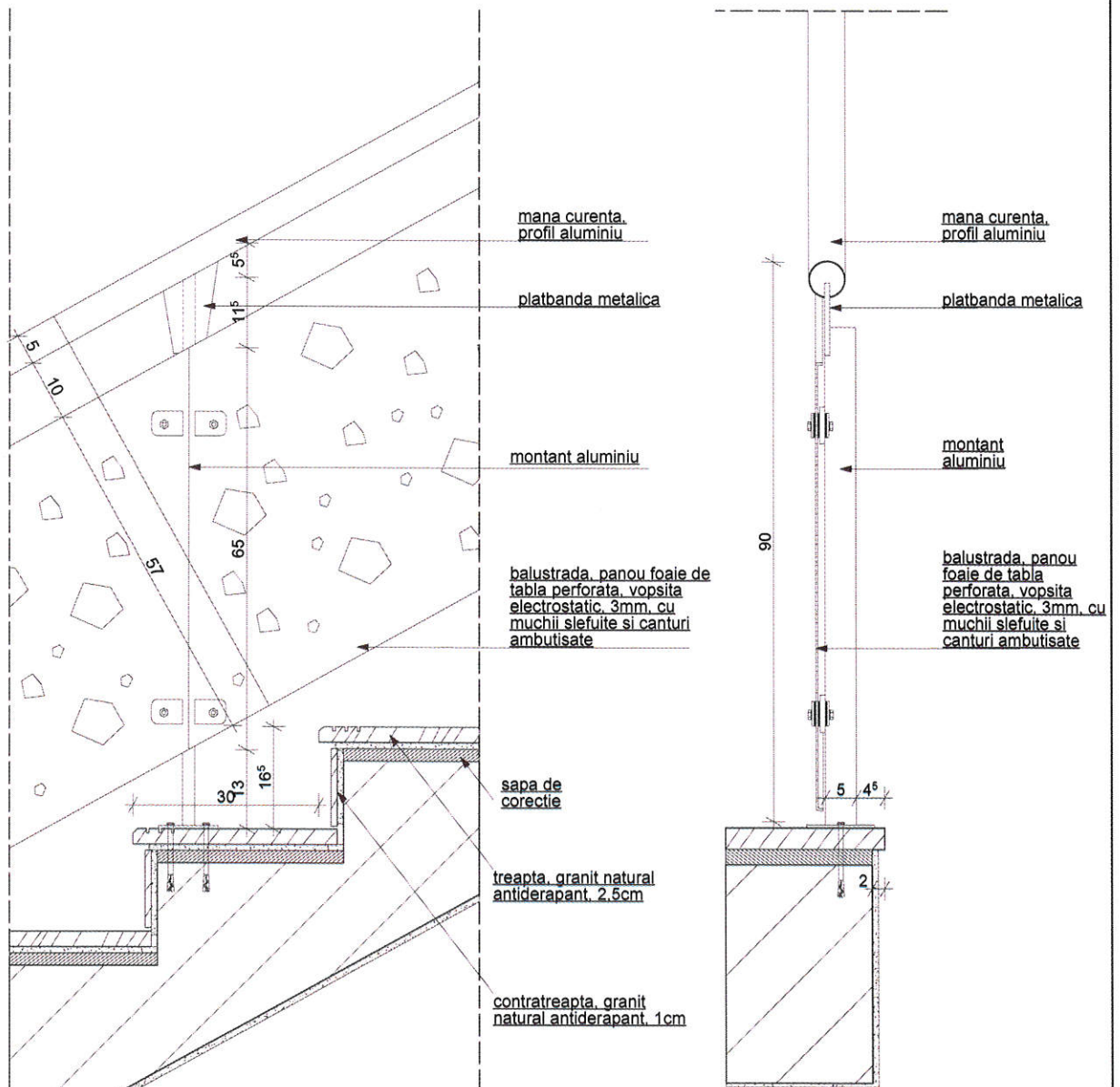

DETALIU SECTIUNE
SCARA 1:10

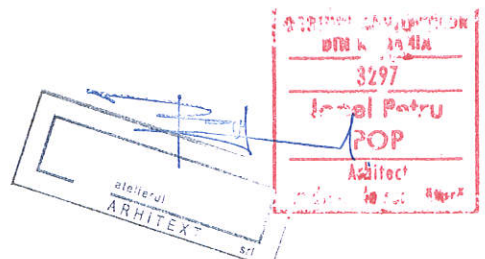

OBIECT 4
DETALII DE EXECUTIE



MODERNIZARE TERASE EXISTENTE,
MONTARE TERMOSISTEM LA FATADE
SI EXTINDERE PE ORIZONTALA CU
CORPURI CONSTRUCTIE D SI E IN
REGIM P+2E+Er LA SCOALA
GIMNAZIALA NR. 30

BENEFICIAR:
SCOALA GIMNAZIALA NR.30 TIMISOARA,
STRADA ASTRILOR, NR. 13, TIMISOARA

ARHITECTURA
Faza: AC, PT, DE, LC, CS

**7. PARDOSELI INTERIOARE DIN COVER PVC
SI SCAFE E1, E2 CORP E**

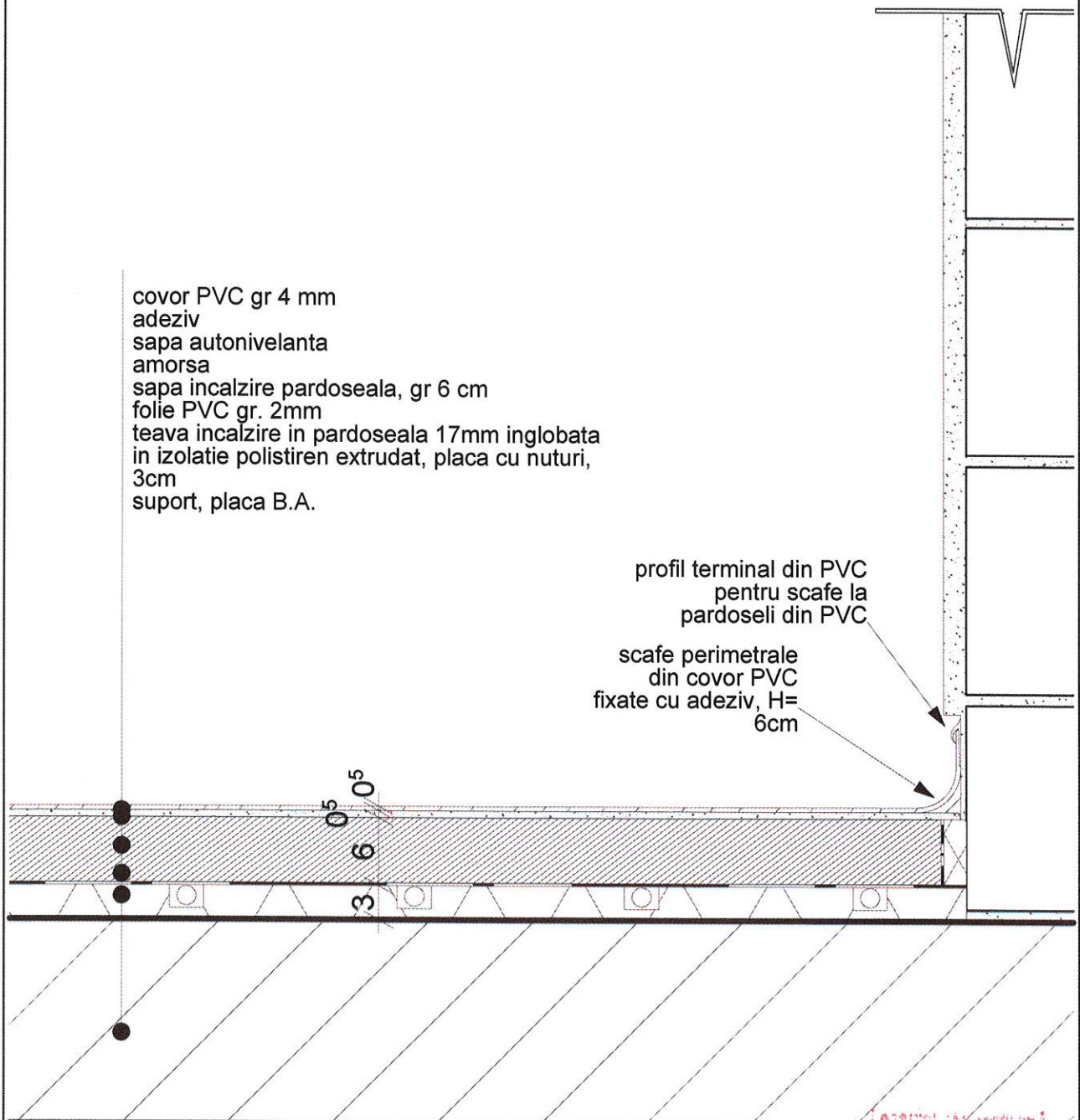

cover PVC gr 4 mm
adeziv
sapa autonivelanta
amorsa
sapa incalzire pardoseala, gr 6 cm
folie PVC gr. 2mm
teava incalzire in pardoseala 17mm inglobata
in izolatie polistiren extrudat, placa cu nuturi,
3cm
suport, placa B.A.

profil terminal din PVC
pentru scafe la
pardoseli din PVC

scafe perimetrare
din cover PVC
fixate cu adeziv, H=
6cm

DETALIU SECTIUNE
SCARA 1:5

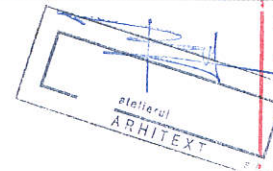

OBIECT 4

DETALII DE EXECUTIE



MODERNIZARE TERASE EXISTENTE,
MONTARE TERMOSISTEM LA FATADE
SI EXTINDERE PE ORIZONTALA CU
CORPURI CONSTRUCTIE D SI E IN
REGIM P+2+Er LA SCOALA
GIMNAZIALA NR. 30

BENEFICIAR:
SCOALA GIMNAZIALA NR.30 TIMISOARA,
STRADA ASTRILOR, NR. 13, TIMISOARA

ARHITECTURA
Faza: AC, PT, DE, LC, CS

8. PARDOSELI INTERIOARE DIN PARCHET LAMELAR SI PLINTE E1,E2 -CORP E

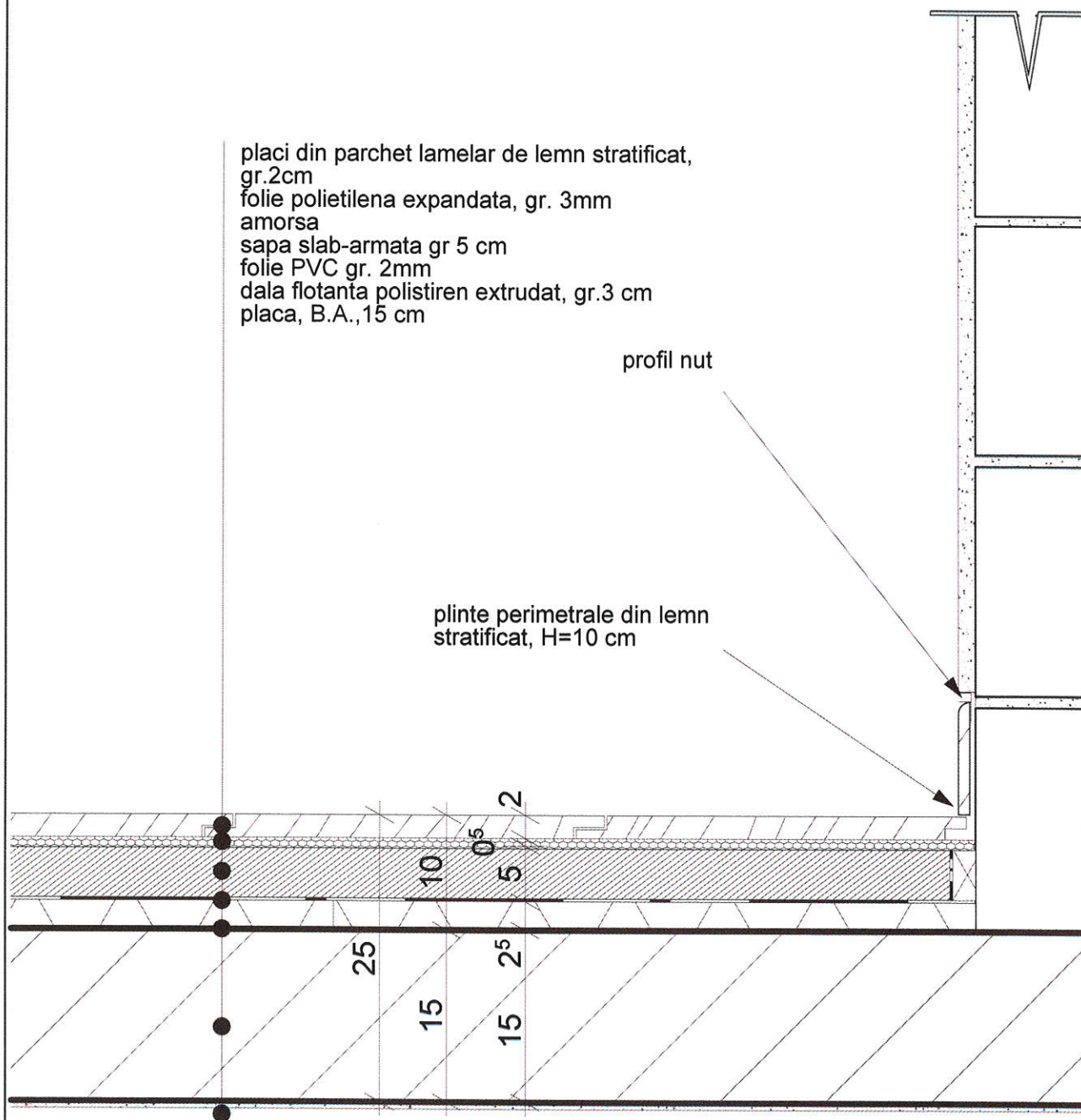

DETALIU SECTIUNE
SCARA 1:5

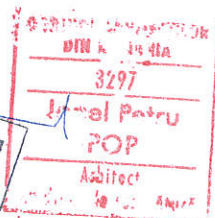
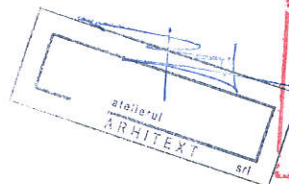

OBIECT 4

DETALII DE EXECUTIE

atelierul
ARHITEXT srl
adresa: localitatea Dumbravita, jud. Timis
Str. Mestecanului, nr.8

MODERNIZARE TERASE EXISTENTE,
MONTARE TERMOSISTEM LA FATADE
SI EXTINDERE PE ORIZONTALA CU
CORPURI CONSTRUCTIE D SI E IN
REGIM P+2E+Er LA SCOALA
GIMNAZIALA NR. 30

BENEFICIAR:
SCOALA GIMNAZIALA NR.30 TIMISOARA,
STRADA ASTRILOR, NR. 13, TIMISOARA

ARHITECTURA
Faza: AC, PT, DE, LC, CS

9. PARDOSELI INTERIOARE RASINI EPOXIDICE DEMISOL CORP E

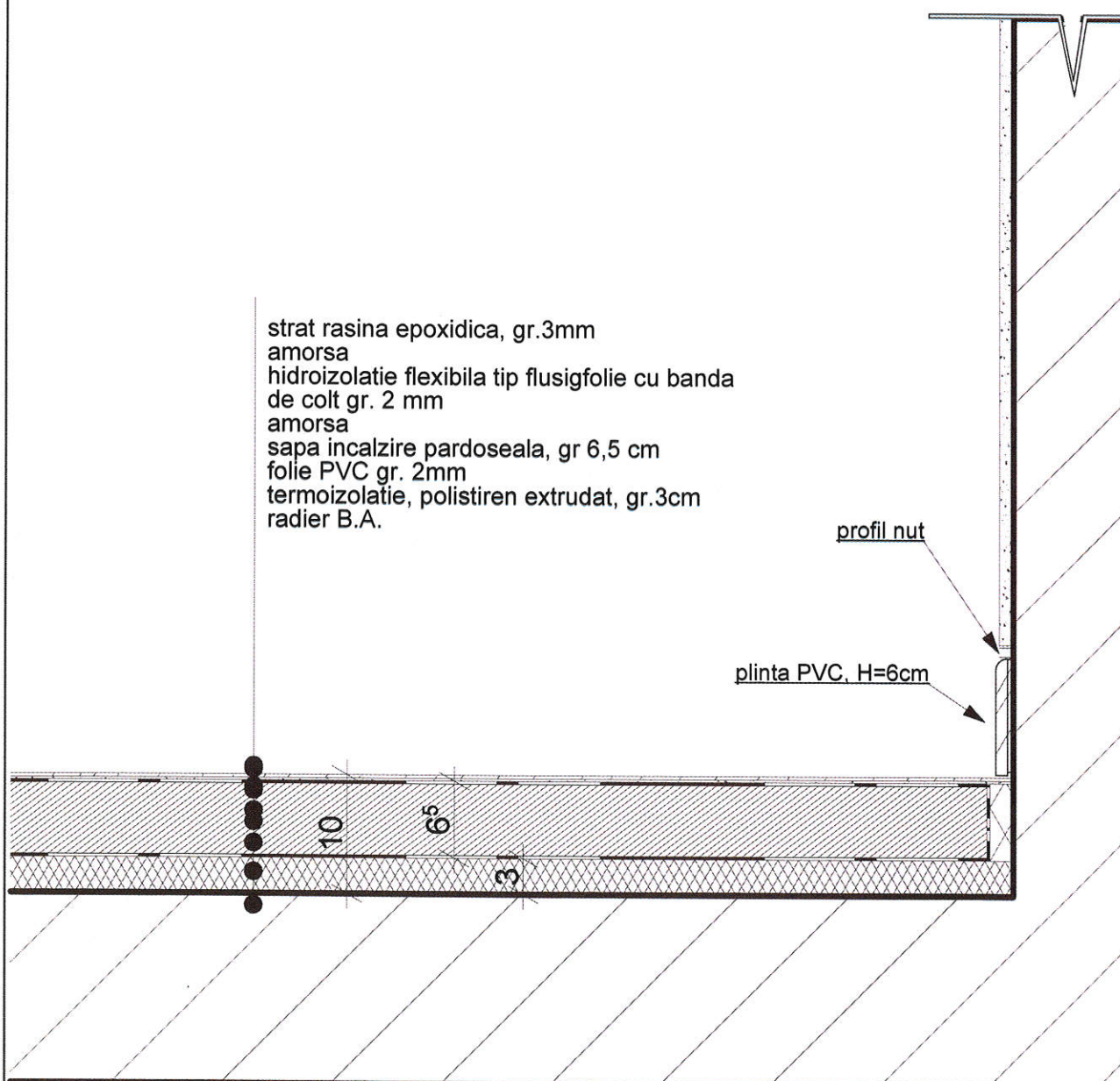

DETALIU SECTIUNE
SCARA 1:5

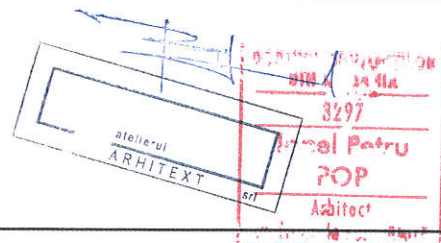

OBIECT 4

DETALII DE EXECUTIE

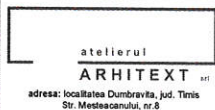

MODERNIZARE TERASE EXISTENTE,
MONTARE TERMOSISTEM LA FATADE
SI EXTINDERE PE ORIZONTALA CU
CORPURI CONSTRUCTIE D SI E IN
REGIM P+2E+Er LA SCOALA
GIMNAZIALA NR. 30

BENEFICIAR:
SCOALA GIMNAZIALA NR.30 TIMISOARA,
STRADA ASTRILOR, NR. 13, TIMISOARA

ARHITECTURA
Faza: AC, PT, DE, LC, CS

10. PARDOSELI INTERIOARE BAZIN APA PSI

membrana PVC cauciucata armata cu fibra de sticla, gr 2mm
adeziv special
amorsa
hidroizolatie flexibila tip flusigfolie cu banda de colt gr. 2 mm
amorsa
sapa slab armata, gr 5 cm
folie PVC gr. 2mm
termoizolatie placi polistiren extrudat gr. 3 cm
scafe fixate cu adeziv h=10 cm

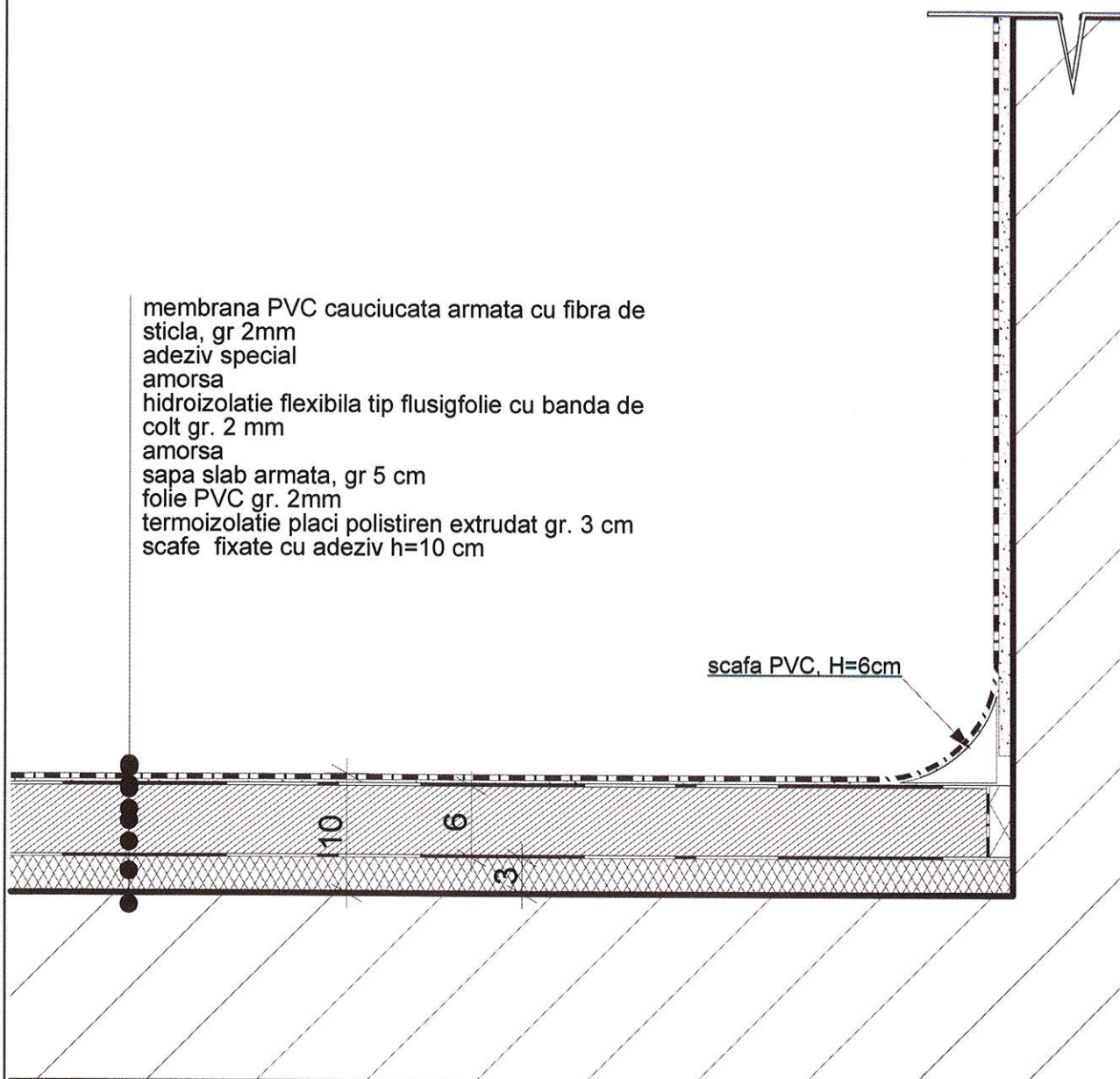

DETALIU SECTIUNE
SCARA 1:5

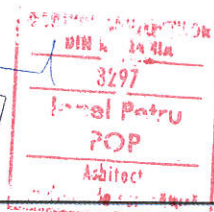
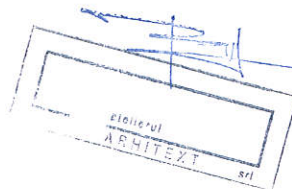

OBIECT 4

DETALII DE EXECUTIE



MODERNIZARE TERASE EXISTENTE,
MONTARE TERMOSISTEM LA FATADE
SI EXTINDERE PE ORIZONTALA CU
CORPURI CONSTRUCTIE D SI E IN
REGIM P+2E+Er LA SCOALA
GIMNAZIALA NR. 30

BENEFICIAR:
SCOALA GIMNAZIALA NR.30 TIMISOARA,
STRADA ASTRILOR, NR. 13, TIMISOARA

ARHITECTURA
Faza: AC, PT, DE, LC, CS

11. PARDOSELI EXTERIOARE DIN PLACI DE GRANIT ANTIDERAPANT PESTE DEMISOL

placi de granit natural antiderapant gr 2cm
adeziv de exterior
amorsa
hidroizolatie flexibila tip flusigfolie cu banda de colt gr. 2 mm
amorsa
sapa slab armata, gr. 5 cm
folie PVC gr. 2 mm
hidroizolatie membrana bituminoasa, 2 strat-uri gr. 8 mm
sapa slab-armata gr. 5 cm
folie PVC gr. 2 mm S=348,85 mp
termoizolatie polistiren extrudat gr. 10 cm
strat DDC si BV
placa de beton armata gr. 15 cm

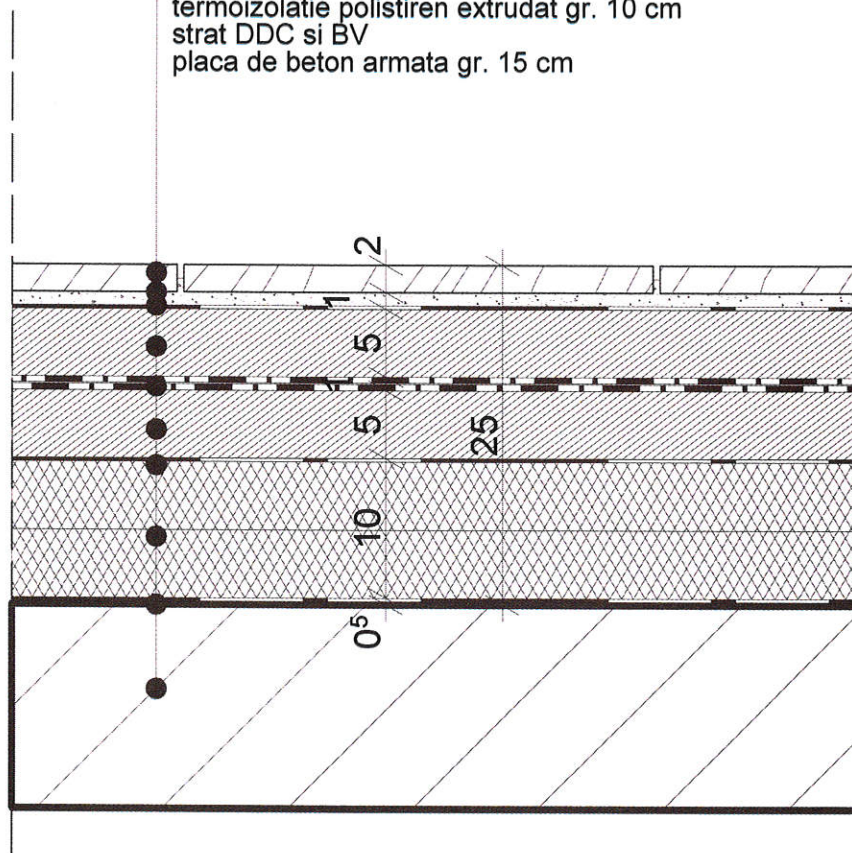

DETALIU SECTIUNE
SCARA 1:5

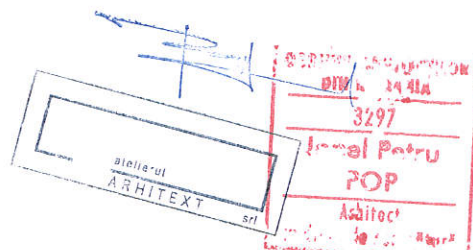

OBIECT 4
DETALII DE EXECUTIE



MODERNIZARE TERASE EXISTENTE,
MONTARE TERMOSISTEM LA FATADE
SI EXTINDERE PE ORIZZONTALA CU
CORPURI CONSTRUCTIE D SI E IN
REGIM P+2E+Er LA SCOALA
GIMNAZIALA NR. 30

BENEFICIAR:
SCOALA GIMNAZIALA NR.30 TIMISOARA,
STRADA ASTRILOR, NR. 13, TIMISOARA
ARHITECTURA
Faza: AC, PT, DE, LC, CS

**12. PARDOSEALA EXTERIOARA TERASA
CIRCULABILA -CORP E**

finisaj, strat vopsea cauciucata, gr. 2 mm
sapa slab-armata gr. 6 cm
folie PVC gr. 2 mm
hidroizolatie membrana bituminoasa, 2 straturi gr. 8 mm
sapa slab-armata gr. 5 cm
folie PVC gr. 2 mm
termoizolatie polistiren extrudat gr. 18 cm
membrana DDC si BV
suport, placa B.A., 15 cm

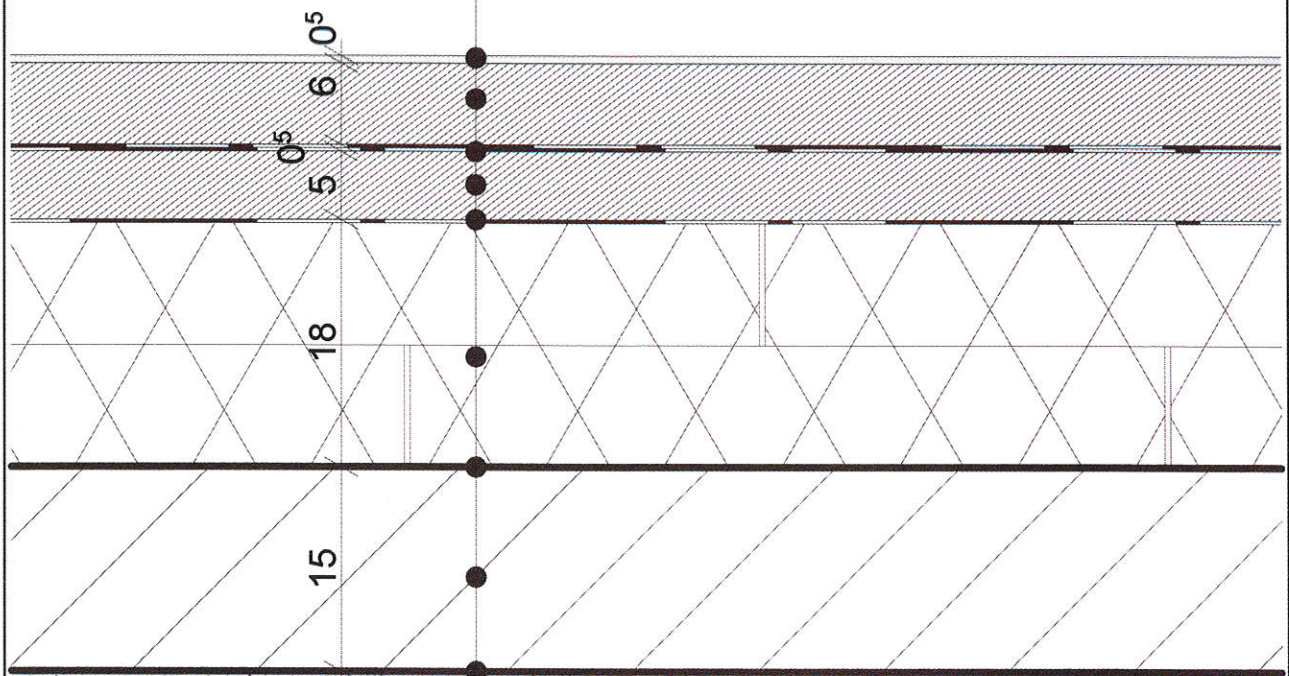

DETALIU SECTIUNE
SCARA 1:5

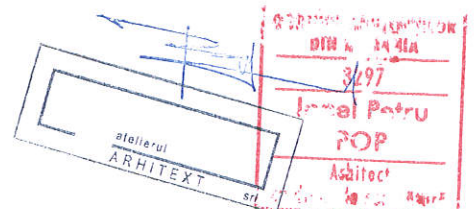

OBIECT 4

DETALII DE EXECUTIE



MODERNIZARE TERASE EXISTENTE,
MONTARE TERMOSISTEM LA FATADE
SI EXTINDERE PE ORIZONTALA CU
CORPURI CONSTRUCTIE D SI E IN
REGIM P+2E+Er LA SCOALA
GIMNAZIALA NR. 30

BENEFICIAR:
SCOALA GIMNAZIALA NR.30 TIMISOARA,
STRADA ASTRILOR, NR. 13, TIMISOARA

ARHITECTURA
Faza: AC, PT, DE, LC, CS

13. PERETI DE INCHIDERE SI COMPARTIMENTARE DIN ZIDARIE CU BLOCURI CERAMICE CU GOLURI gr. 25 cm si gr. 15 cm

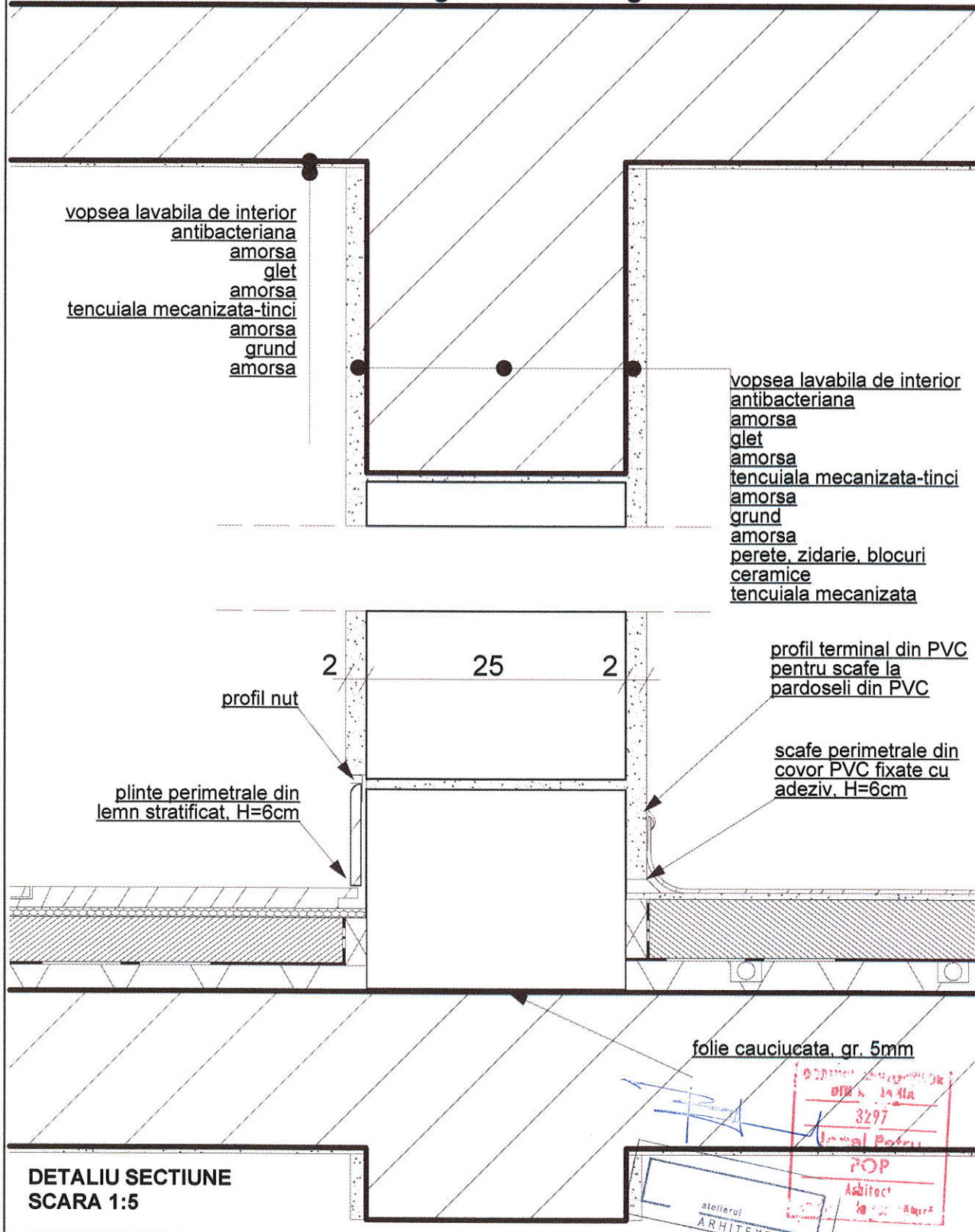

OBIECT 4

DETALII DE EXECUTIE



MODERNIZARE TERASE EXISTENTE,
MONTARE TERMOSISTEM LA FATADE
SI EXTINDERE PE ORIZONTALA CU
CORPURI CONSTRUCTIE D SI E IN
REGIM P+2+E+Er LA SCOALA
GIMNAZIALA NR. 30

BENEFICIAR:
SCOALA GIMNAZIALA NR.30 TIMISOARA,
STRADA ASTRILOR, NR. 13, TIMISOARA

ARHITECTURA
Faza: AC, PT, DE, LC, CS

14. PERETI DE COMPARTIMENTARE DIN STRUCTURI METALICE SI PLACI DIN GIPS CARTON IN SPATII UScate

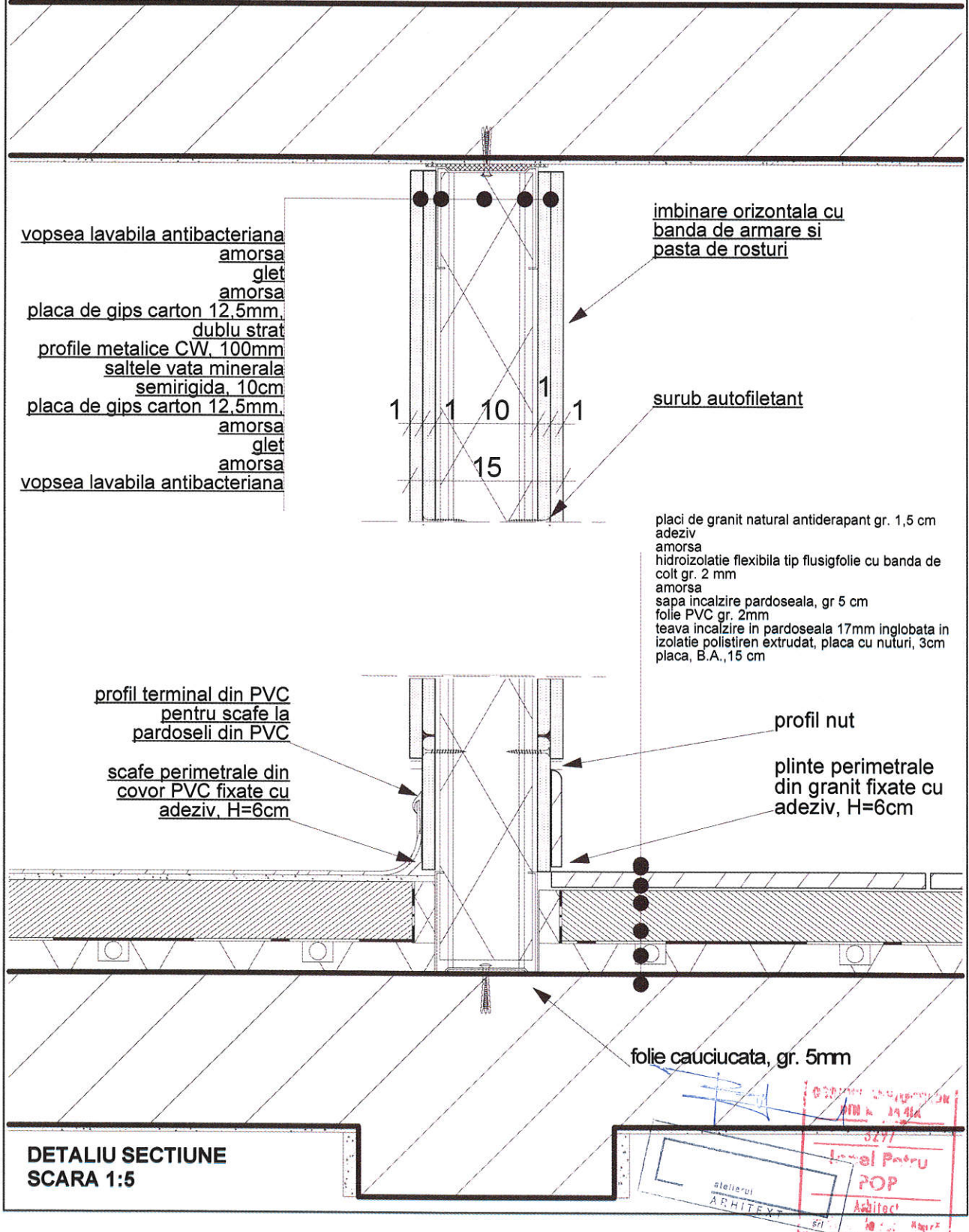

OBIECT 4

DETALII DE EXECUTIE



MODERNIZARE TERASE EXISTENTE,
MONTARE TERMOSISTEM LA FATADE
SI EXTINDERE PE ORIZONTALA CU
CORPURI CONSTRUCTIE D SI E IN
REGIM P+2E+Er LA SCOALA
GIMNAZIALA NR. 30

BENEFICIAR:
SCOALA GIMNAZIALA NR.30 TIMISOARA,
STRADA ASTRILOR, NR. 13, TIMISOARA

ARHITECTURA
Faza: AC, PT, DE, LC, CS

15. TENCUIELI INTERIOARE LA PERETI DE INCHIDERE SI COMPARTIMENTARE DIN ZIDARIE CU BLOCURI CERAMICE CU GOLURI gr. 25 cm si gr. 30 cm

DETALIU SECTIUNE SCARA 1:5

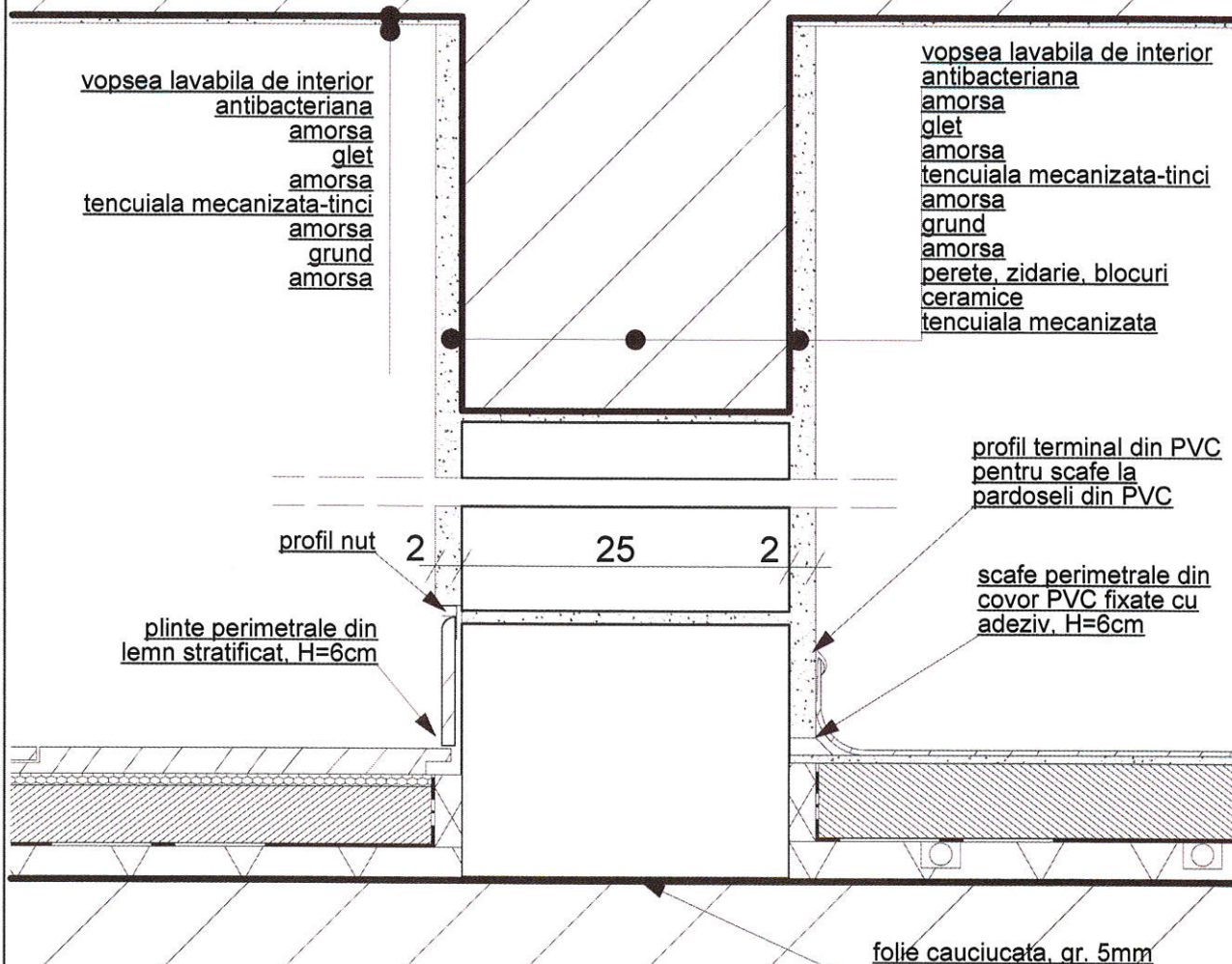

DETALIU PLAN SCARA 1:5

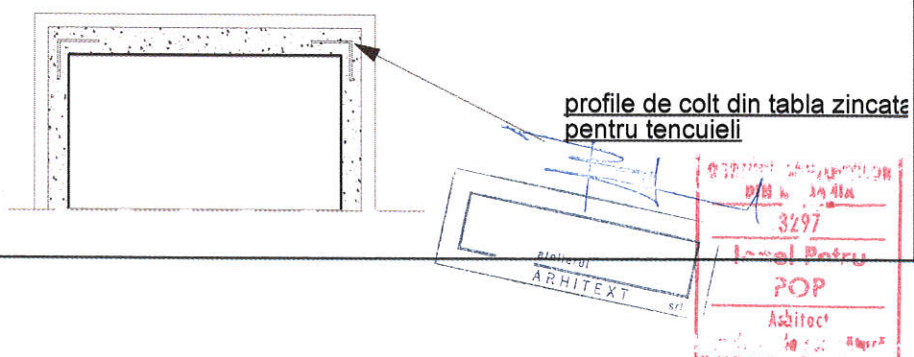

OBIECT 4
DETALII DE EXECUTIE

atelierul
ARHITEXT srl
adresa: localitatea Dumbravita, jud. Timis
Str. Mesteacanului, nr.8

MODERNIZARE TERASE EXISTENTE,
MONTARE TERMOSISTEM LA FATADE
SI EXTINDERE PE ORIZZONTALA CU
CORPURI CONSTRUCTIE D SI E IN
REGIM P+2E+Er LA SCOALA
GIMNAZIALA NR. 30

BENEFICIAR:
SCOALA GIMNAZIALA NR.30 TIMISOARA,
STRADA ASTRILOR, NR. 13, TIMISOARA
ARHITECTURA
Faza: AC, PT, DE, LC, CS

**16. ZUGRAVELI INTERIOARE LA PERETI DE
INCHIDERE SI COMPARTIMENTARE DIN ZIDARIE CU
BLOCURI CERAMICE CU GOLURI gr. 25 cm si gr. 30 cm**

**DETALIU SECTIUNE
SCARA 1:5**

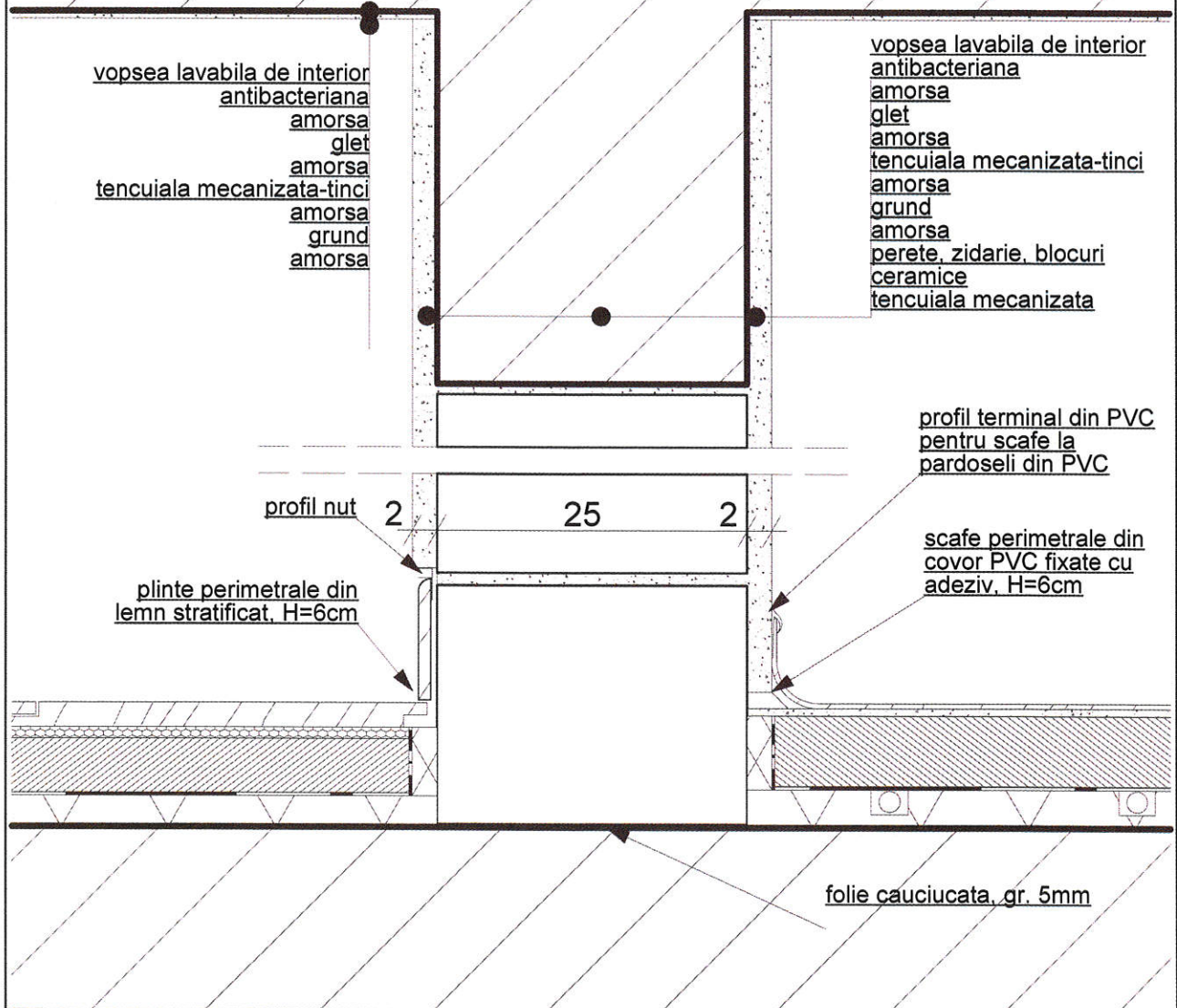

**DETALIU PLAN
SCARA 1:5**

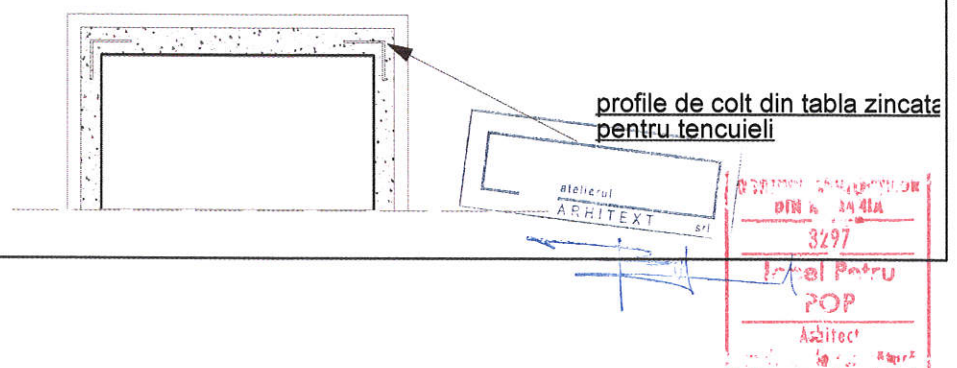

profile de colt din tabla zincata
pentru tencuieli

atelierul
ARHITEXT srl

PROIECT DE CONSTRUCTII
DIN 6 14/11A
3297
Inel Pentru
POP
Arhitect
10.02.2012

OBIECT 4

DETALII DE EXECUTIE



MODERNIZARE TERASE EXISTENTE,
MONTARE TERMOSISTEM LA FATADE
SI EXTINDERE PE ORIZONTALA CU
CORPURI CONSTRUCTIE D SI E IN
REGIM P+2E+Er LA SCOALA
GIMNAZIALA NR. 30

BENEFICIAR:
SCOALA GIMNAZIALA NR.30 TIMISOARA,
STRADA ASTRILOR, NR. 13, TIMISOARA
ARHITECTURA
Faza: AC, PT, DE, LC, CS

17. TENCUIELI SI ZUGRAVELI LA PERETI DIN BETON ARMAT

DETALIU SECTIUNE
SCARA 1:5

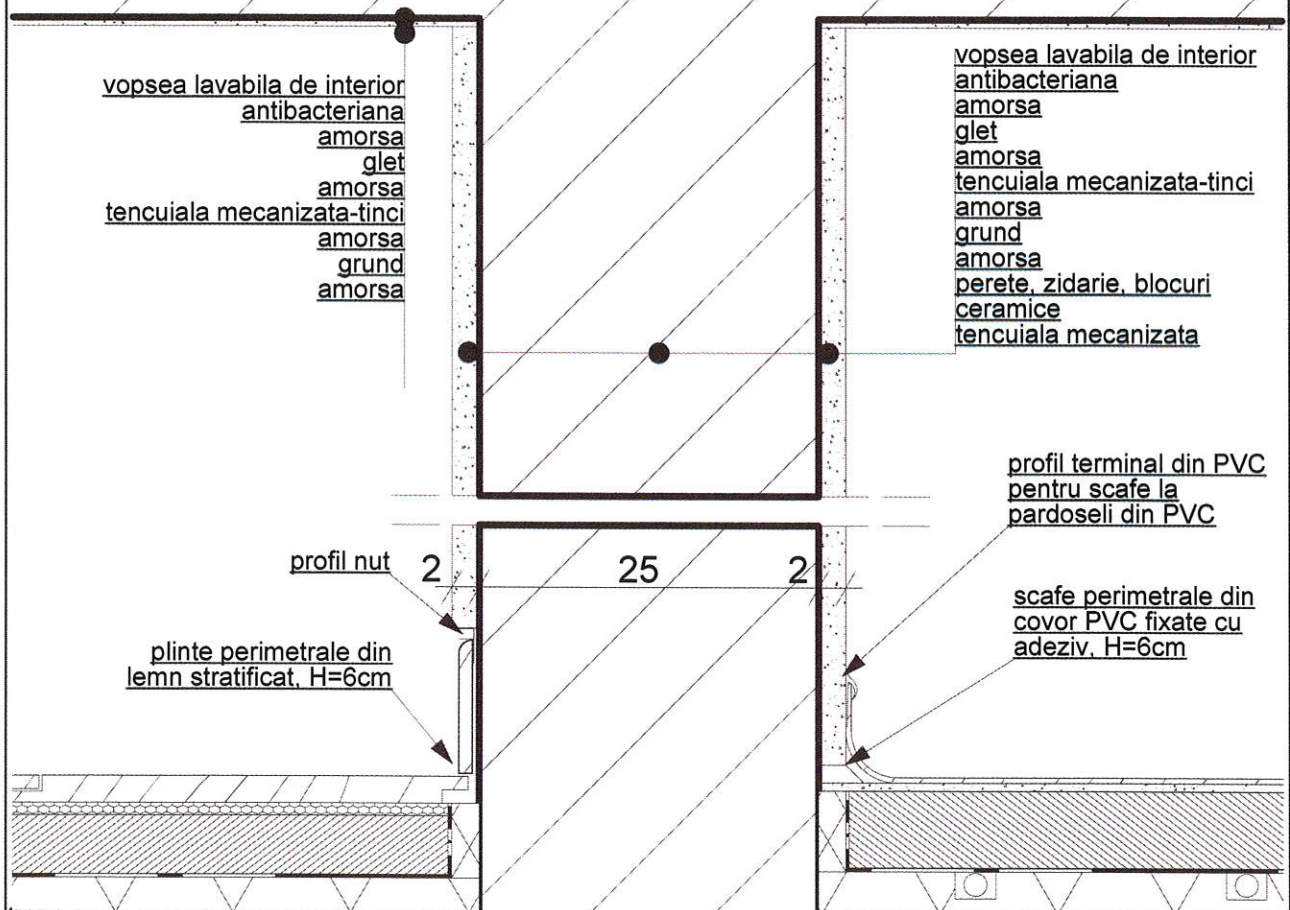

DETALIU PLAN
SCARA 1:5

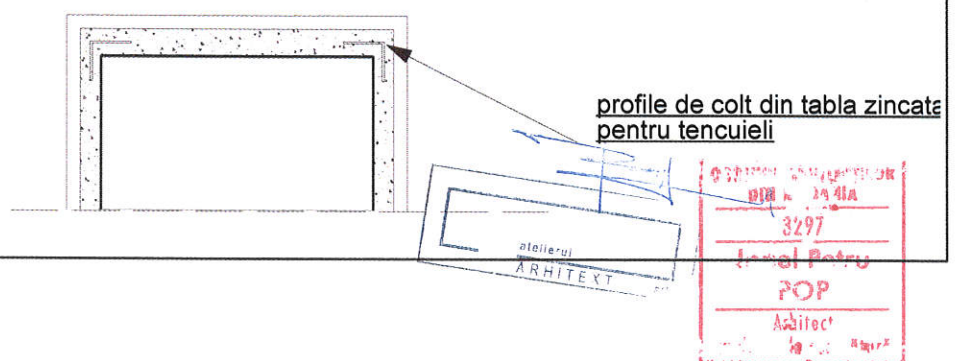

OBIECT 4

DETALII DE EXECUTIE



MODERNIZARE TERASE EXISTENTE,
MONTARE TERMOSISTEM LA FATADE
SI EXTINDERE PE ORIZONTALA CU
CORPURI CONSTRUCTIE D SI E IN
REGIM P+2E+Er LA SCOALA
GIMNAZIALA NR. 30

BENEFICIAR:
SCOALA GIMNAZIALA NR.30 TIMISOARA,
STRADA ASTRILOR, NR. 13, TIMISOARA

ARHITECTURA
Faza: AC, PT, DE, LC, CS

18. TENCUIELI SI HIDROIZOLATIE LA PERETI DIN BETON ARMAT REZERVA DE APA PSI

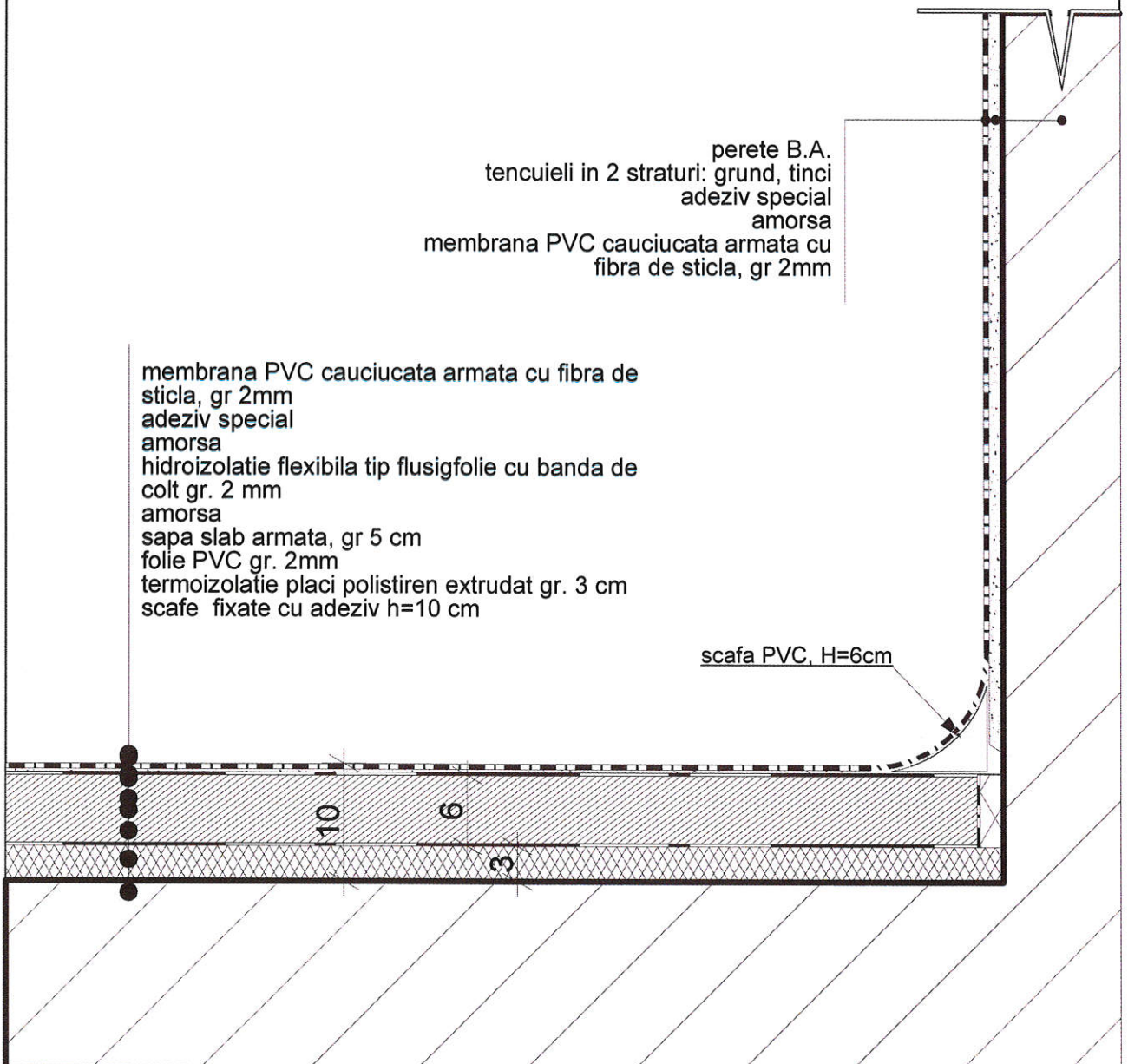

perete B.A.
tencuieli in 2 straturi: grund, tinci
adeziv special
amorsa
membrana PVC cauciucata armata cu
fibra de sticla, gr 2mm

membrana PVC cauciucata armata cu fibra de
sticla, gr 2mm
adeziv special
amorsa
hidroizolatie flexibila tip flusigfolie cu banda de
colt gr. 2 mm
amorsa
sapa slab armata, gr 5 cm
folie PVC gr. 2mm
termoizolatie placi polistiren extrudat gr. 3 cm
scafe fixate cu adeziv h=10 cm

scafa PVC, H=6cm

DETALIU SECTIUNE
SCARA 1:5

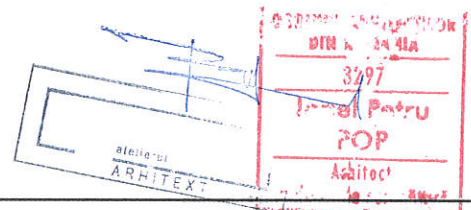

OBIECT 4

DETALII DE EXECUTIE



MODERNIZARE TERASE EXISTENTE,
MONTARE TERMOSISTEM LA FATADE
SI EXTINDERE PE ORIZONTALA CU
CORPURI CONSTRUCTIE D SI E IN
REGIM P+2E+Er LA SCOALA
GIMNAZIALA NR. 30

BENEFICIAR:
SCOALA GIMNAZIALA NR.30 TIMISOARA,
STRADA ASTRILOR, NR. 13, TIMISOARA

ARHITECTURA
Faza: AC, PT, DE, LC, CS

19. TENCUIELI SI ZUGRAVELI LA STALPI SI GRINZI DIN BETON ARMAT

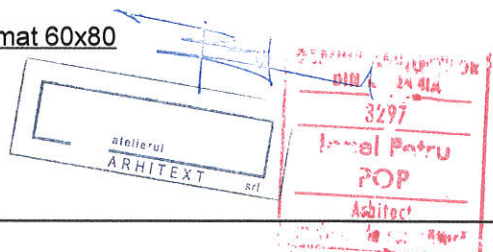
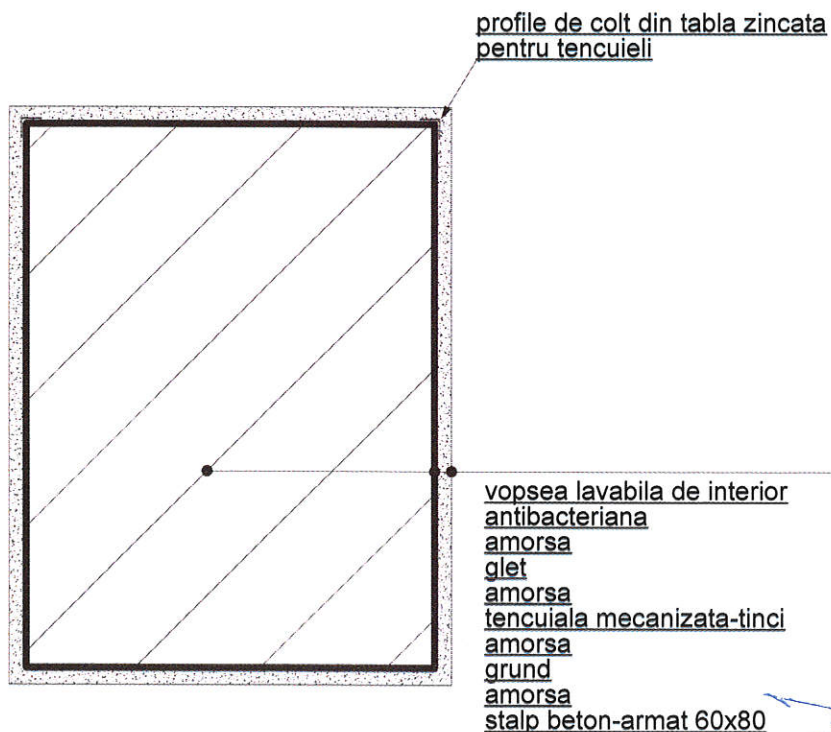
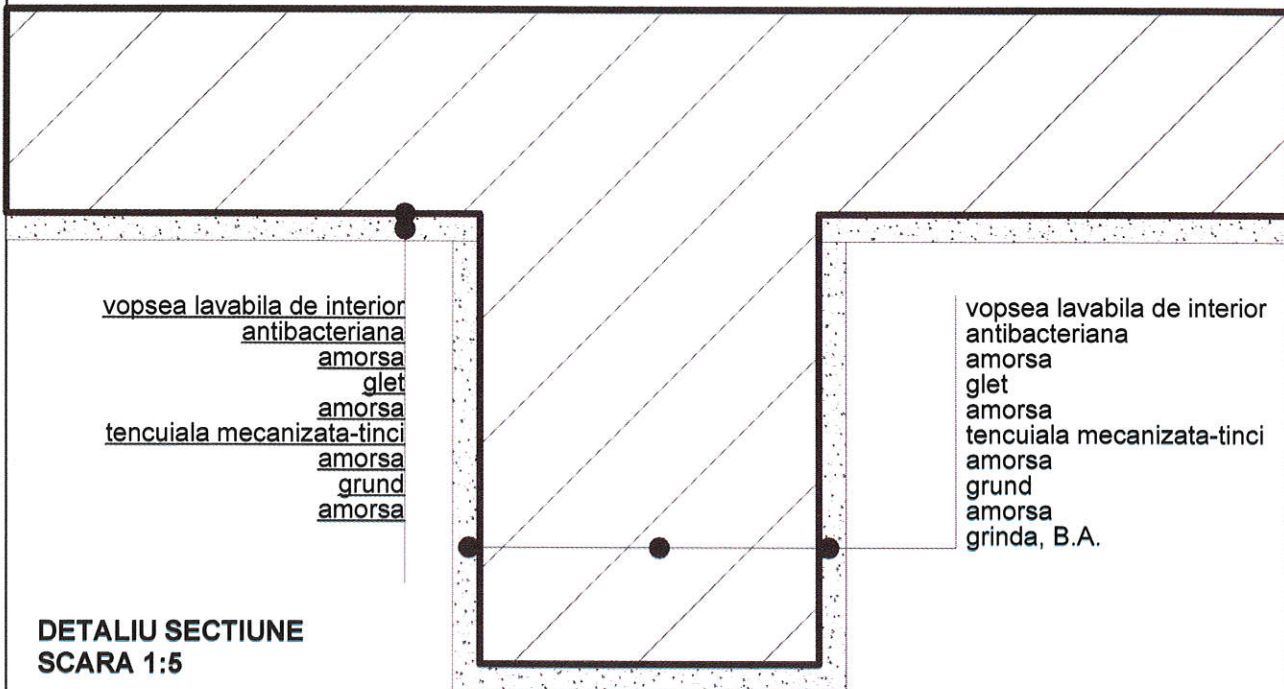

OBIECT 4

DETALII DE EXECUTIE

atelierul
ARHITEXT SRL
adresa: localitatea Dumbravita, jud. Timis
Str. Mesteacanului, nr.8

MODERNIZARE TERASE EXISTENTE,
MONTARE TERMOSISTEM LA FATADE
SI EXTINDERE PE ORIZONTALA CU
CORPURI CONSTRUCTIE D SI E IN
REGIM P+2E+Er LA SCOALA
GIMNAZIALA NR. 30

BENEFICIAR:
SCOALA GIMNAZIALA NR.30 TIMISOARA,
STRADA ASTRILOR, NR. 13, TIMISOARA

ARHITECTURA
Faza: AC, PT, DE, LC, CS

20. TENCUIELI SI ZUGRAVELI INTERIOARE INTRADOSURI, RAMPE SI PODESTE SCARI

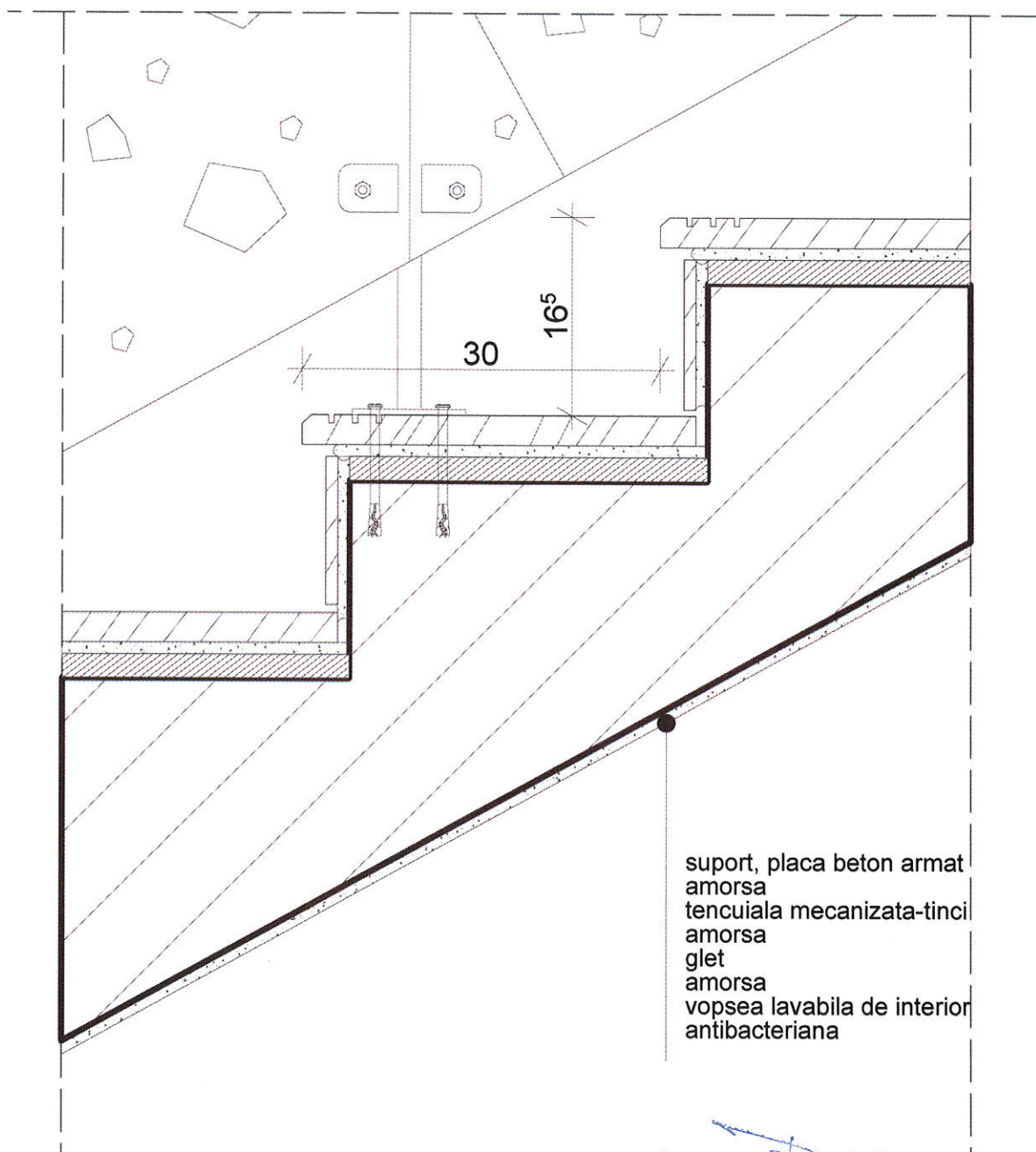

suport, placa beton armat
amorsa
tencuiala mecanizata-tinci
amorsa
glet
amorsa
vopsea lavabila de interior
antibacteriana

DETALIU SECTIUNE
SCARA 1:5

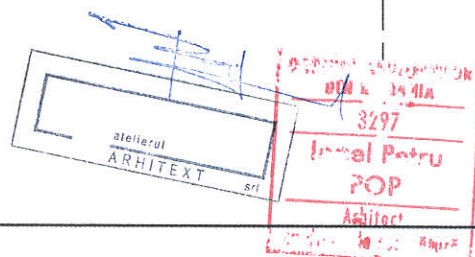

OBIECT 4
DETALII DE EXECUTIE



MODERNIZARE TERASE EXISTENTE,
MONTARE TERMOSISTEM LA FATADE
SI EXTINDERE PE ORIZONTALA CU
CORPURI CONSTRUCTIE D SI E IN
REGIM P+2E+Er LA SCOALA
GIMNAZIALA NR. 30

BENEFICIAR:
SCOALA GIMNAZIALA NR.30 TIMISOARA,
STRADA ASTRILOR, NR. 13, TIMISOARA

ARHITECTURA
Faza: AC, PT, DE, LC, CS

**21. TENCUIELI SI ZUGRAVELI INTERIOARE
TAVANE**

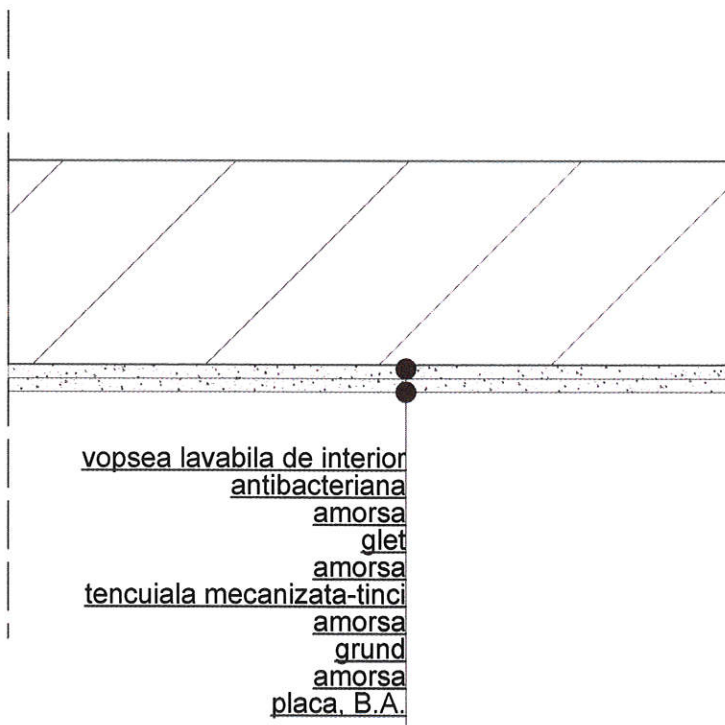

DETALIU SECTIUNE
SCARA 1:5



OBIECT 4

DETALII DE EXECUTIE



MODERNIZARE TERASE EXISTENTE,
MONTARE TERMOSISTEM LA FATADE
SI EXTINDERE PE ORIZONTALA CU
CORPURI CONSTRUCTIE D SI E IN
REGIM P+2+Er LA SCOALA
GIMNAZIALA NR. 30

BENEFICIAR:
SCOALA GIMNAZIALA NR.30 TIMISOARA,
STRADA ASTRILOR, NR. 13, TIMISOARA

ARHITECTURA
Faza: AC, PT, DE, LC, CS

22. TAVANE SUSPENDATE INTERIOARE DIN STRUCTURI DE GIPS CARTON IN CAMP CONTINUU IN SPATII USCATE

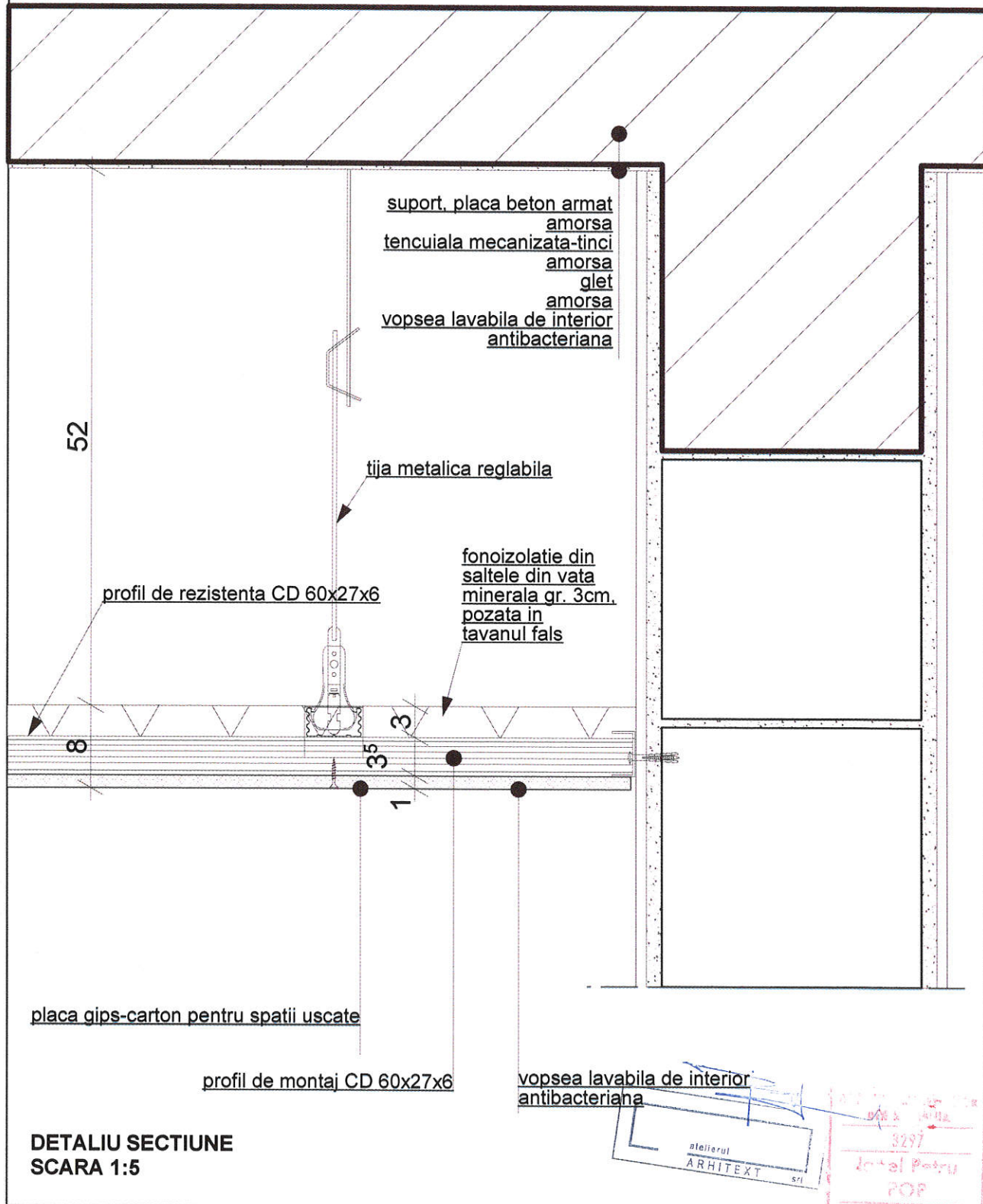

DETALIU SECTIUNE
SCARA 1:5

OBIECT 4

DETALII DE EXECUTIE



MODERNIZARE TERASE EXISTENTE,
MONTARE TERMOSISTEM LA FATADE
SI EXTINDERE PE ORIZONTALA CU
CORPURI CONSTRUCTIE D SI E IN
REGIM P+2E+Er LA SCOALA
GIMNAZIALA NR. 30

BENEFICIAR:
SCOALA GIMNAZIALA NR.30 TIMISOARA,
STRADA ASTRILOR, NR. 13, TIMISOARA

ARHITECTURA
Faza: AC, PT, DE, LC, CS

23. TAVANE SUSPENDATE EXTERIOARE DIN STRUCTURI METALICE SI PLACI FIBRO BETON

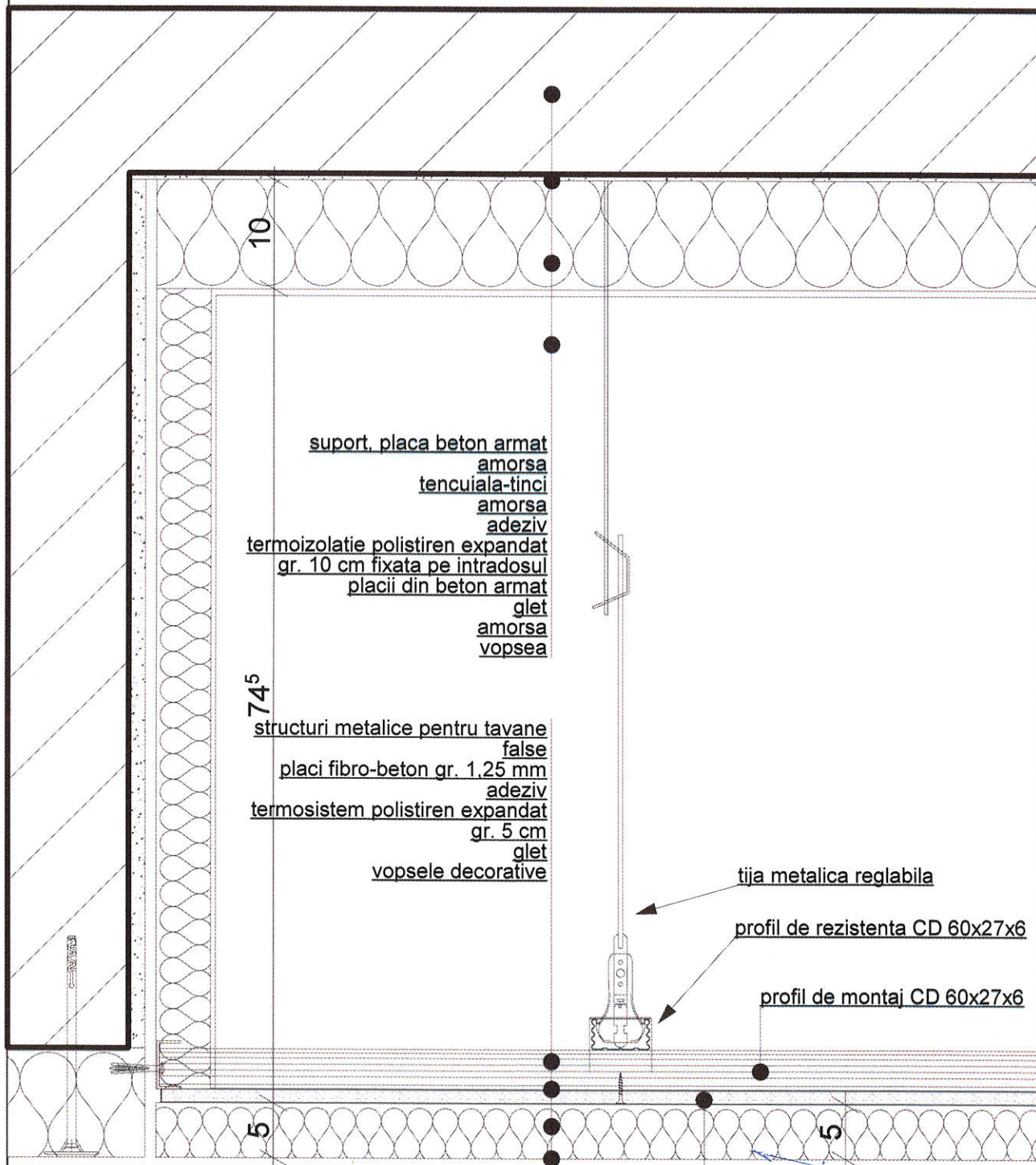

placi fibro beton 12,5mm

DETALIU SECTIUNE
SCARA 1:5

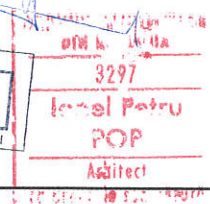
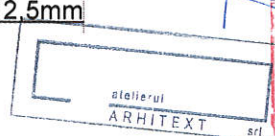

OBIECT 4

DETALII DE EXECUTIE



MODERNIZARE TERASE EXISTENTE,
MONTARE TERMOSISTEM LA FATADE
SI EXTINDERE PE ORIZONTALA CU
CORPURI CONSTRUCTIE D SI E IN
REGIM P+2E+Er LA SCOALA
GIMNAZIALA NR. 30

BENEFICIAR:
SCOALA GIMNAZIALA NR.30 TIMISOARA,
STRADA ASTRILOR, NR. 13, TIMISOARA

ARHITECTURA
Faza: AC, PT, DE, LC, CS

24. TAVANE SUSPENDATE INTERIOARE DIN PLACI METALICE PERFORATE LAMELARE

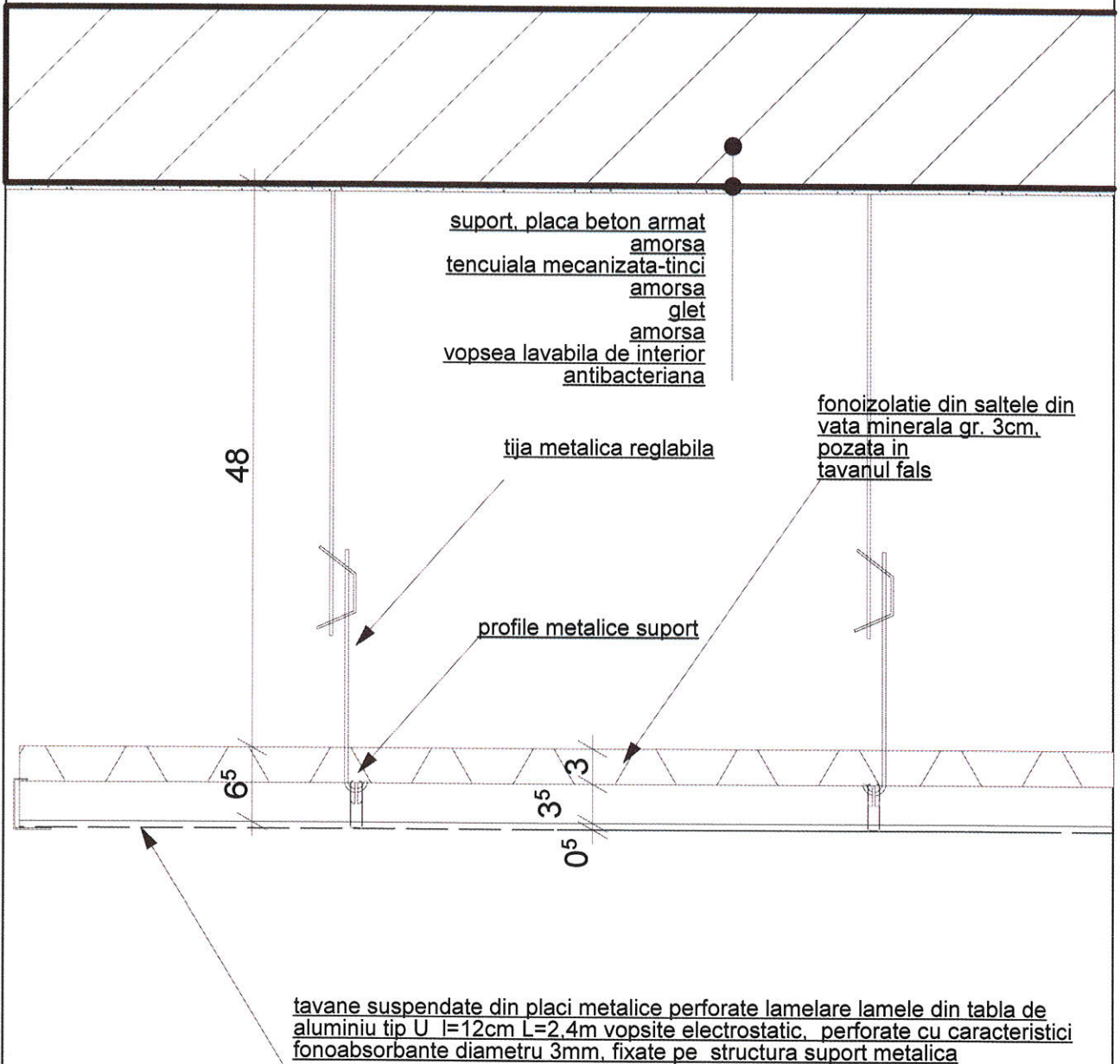

DETALIU SECTIUNE
SCARA 1:5

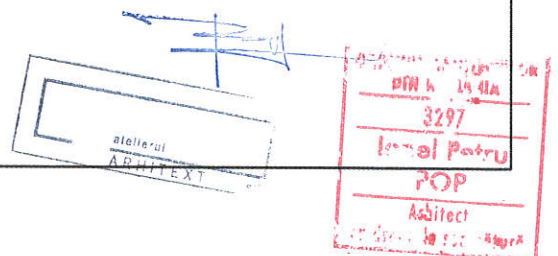

OBIECT 4

DETALII DE EXECUTIE



MODERNIZARE TERASE EXISTENTE,
MONTARE TERMOSISTEM LA FATADE
SI EXTINDERE PE ORIZONTALA CU
CORPURI CONSTRUCTIE D SI E IN
REGIM P+2+Er LA SCOALA
GIMNAZIALA NR. 30

BENEFICIAR:
SCOALA GIMNAZIALA NR.30 TIMISOARA,
STRADA ASTRILOR, NR. 13, TIMISOARA

ARHITECTURA
Faza: AC, PT, DE, LC, CS

25. TAVANE CU TRATAMENTE ACUSTICE CORP D ETAJ 1 SI ETAJ 2 PE HOLURI

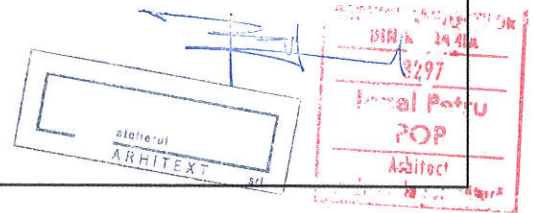
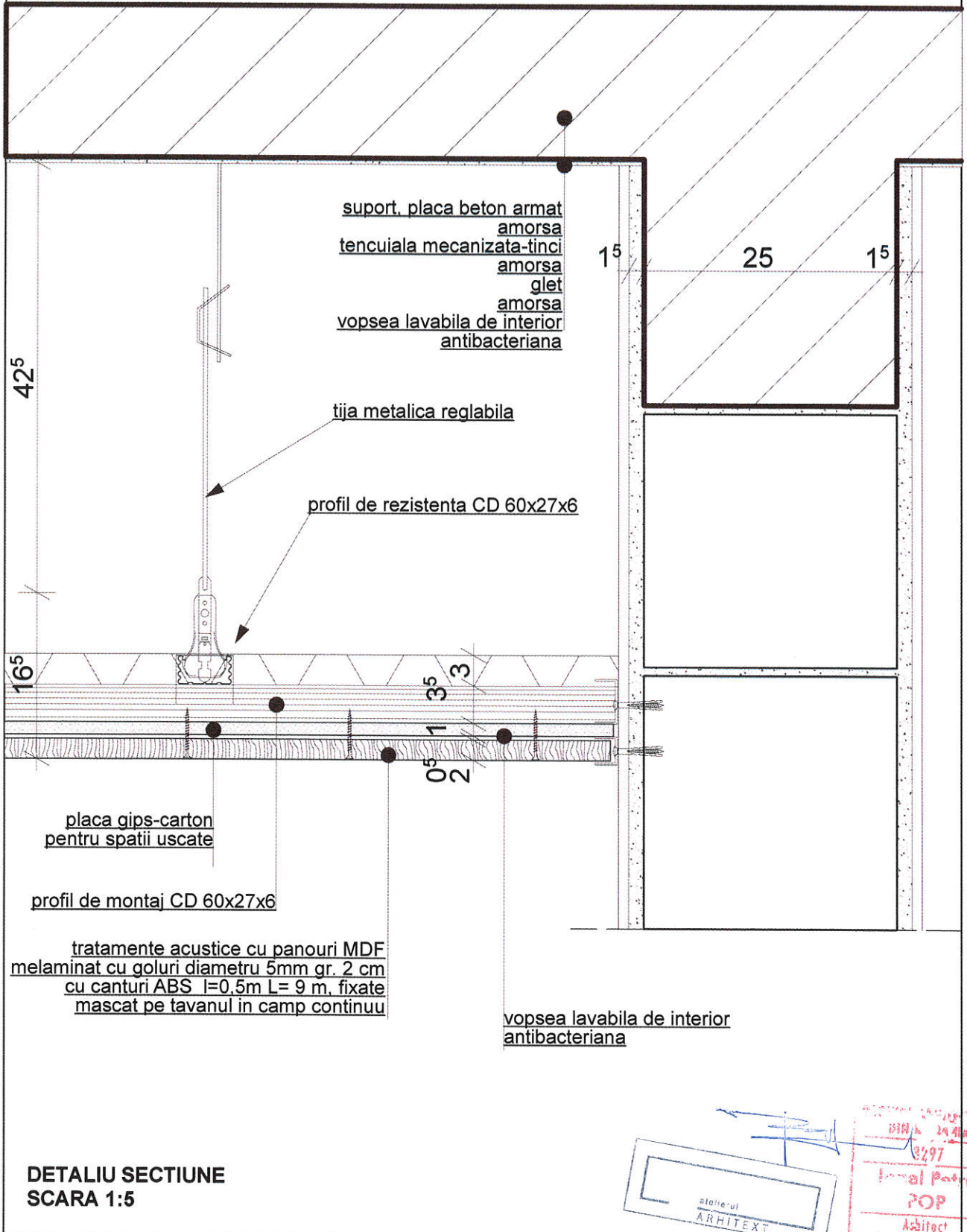

OBIECT 4

DETALII DE EXECUTIE



MODERNIZARE TERASE EXISTENTE,
MONTARE TERMOSISTEM LA FATADE
SI EXTINDERE PE ORIZONTALA CU
CORPURI CONSTRUCTIE D SI E IN
REGIM P+2E+Er LA SCOALA
GIMNAZIALA NR. 30

BENEFICIAR:
SCOALA GIMNAZIALA NR.30 TIMISOARA,
STRADA ASTRILOR, NR. 13, TIMISOARA
ARHITECTURA
Faza: AC, PT, DE, LC, CS

26. TRATAMENTE ACUSTICE LA PERETI HOLURI DE NIVEL CORP D ETAJ 1 SI ETAJ 2

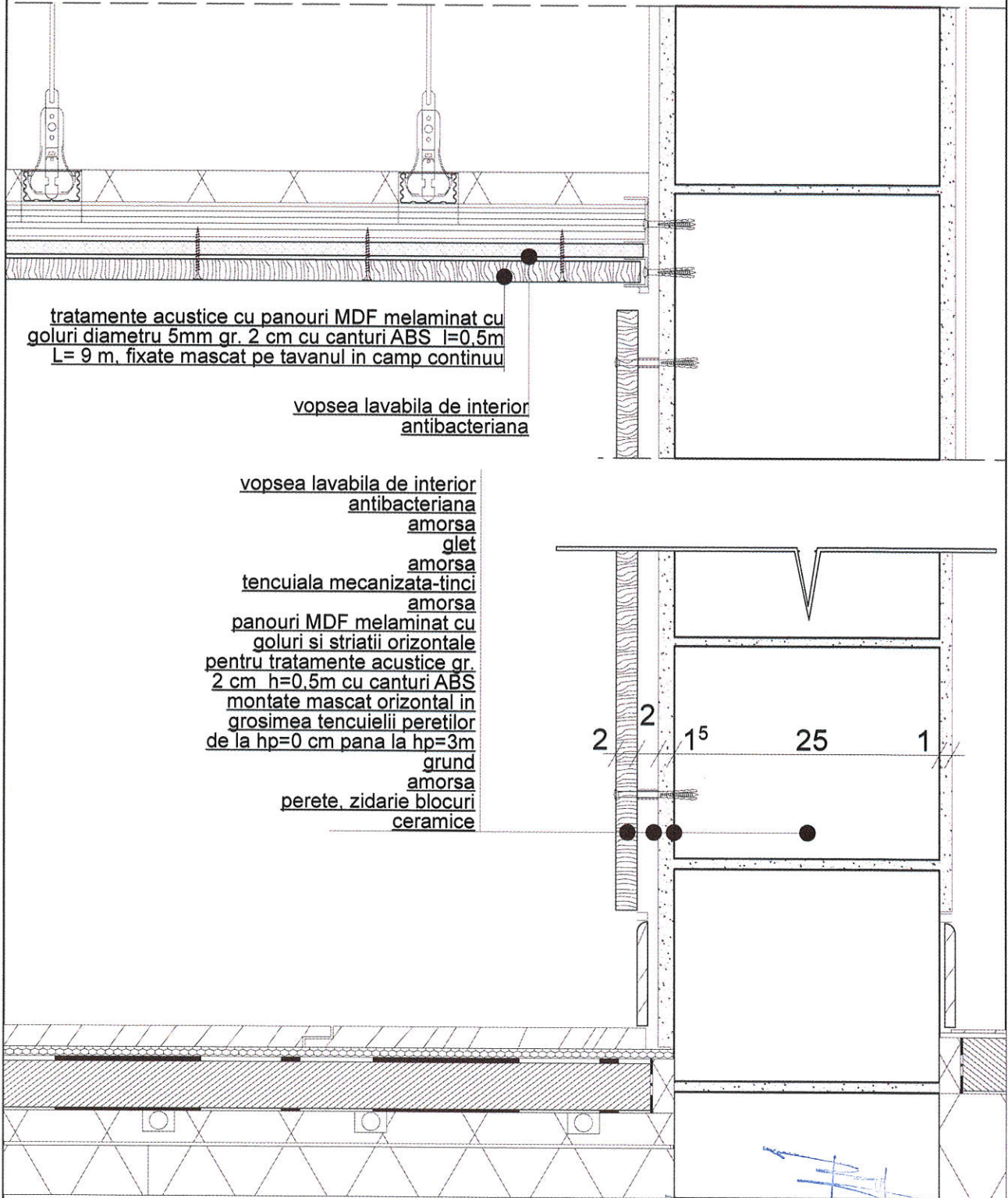

tratamente acustice cu panouri MDF melaminat cu
goluri diametru 5mm gr. 2 cm cu canturi ABS l=0,5m
L= 9 m. fixate mascat pe tavanul in camp continuu

vopsea lavabila de interior
antibacteriana

vopsea lavabila de interior
antibacteriana
amorsa
glet
amorsa
tencuiala mecanizata-tinci
amorsa
panouri MDF melaminat cu
goluri si striatii orizontale
pentru tratamente acustice gr.
2 cm h=0,5m cu canturi ABS
montate mascat orizontal in
grosimea tencuiei peretilor
de la hp=0 cm pana la hp=3m
grund
amorsa
perete, zidarie blocuri
ceramice

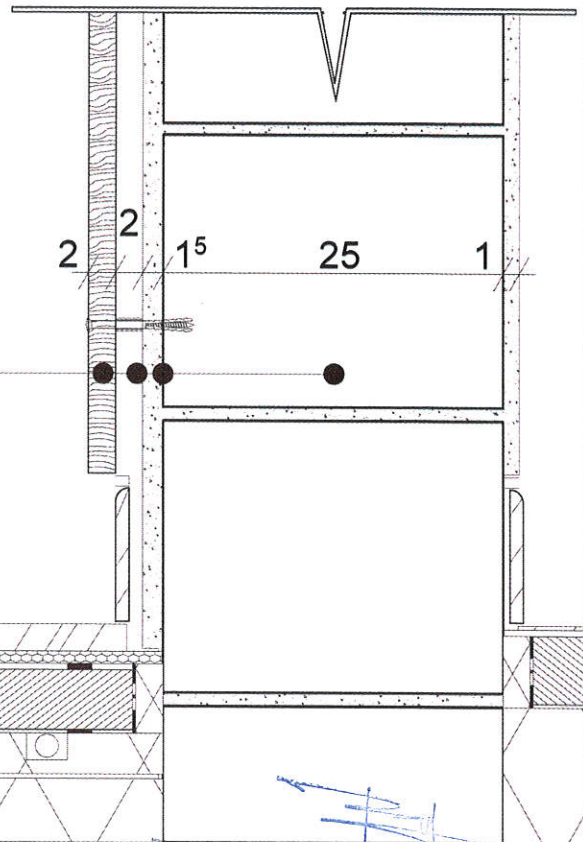

DETALIU SECTIUNE
SCARA 1:5

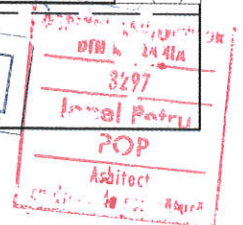

OBIECT 4

DETALII DE EXECUTIE



MODERNIZARE TERASE EXISTENTE,
MONTARE TERMOSISTEM LA FATADE
SI EXTINDERE PE ORIZONTALA CU
CORPURI CONSTRUCTIE D SI E IN
REGIM P+2E+Er LA SCOALA
GIMNAZIALA NR. 30

BENEFICIAR:
SCOALA GIMNAZIALA NR.30 TIMISOARA,
STRADA ASTRILOR, NR. 13, TIMISOARA

ARHITECTURA
Faza: AC, PT, DE, LC, CS

27.a. FINISAJE EXTERIOARE TERMOSISTEM SI VOPSELE DECORATIVE CORP E

termosistem din placi
de polistiren expandat
grafitat gr. 10 cm

glet de exterior, masa
de spaclu pe fibra de
sticla, profile de colt

vopsele decorative de exterior
termosistem din placi
rigide bazaltice gr. 10 cm

profil cu picurator

bariera termica

vitrine cu tamplarie din aluminiu
realizata din profile cu bariera
termica cu ochiuri fixe si mobile,
cu garnitura de etanseizare
EPDM, cu geam termoizolant cu
sticla laminata

glaf exterior, aluminiu, vopsit
electrostatic

termosistem din placi
de polistiren expandat
grafitat gr. 10 cm

DETALIU SECTIUNE
SCARA 1:5

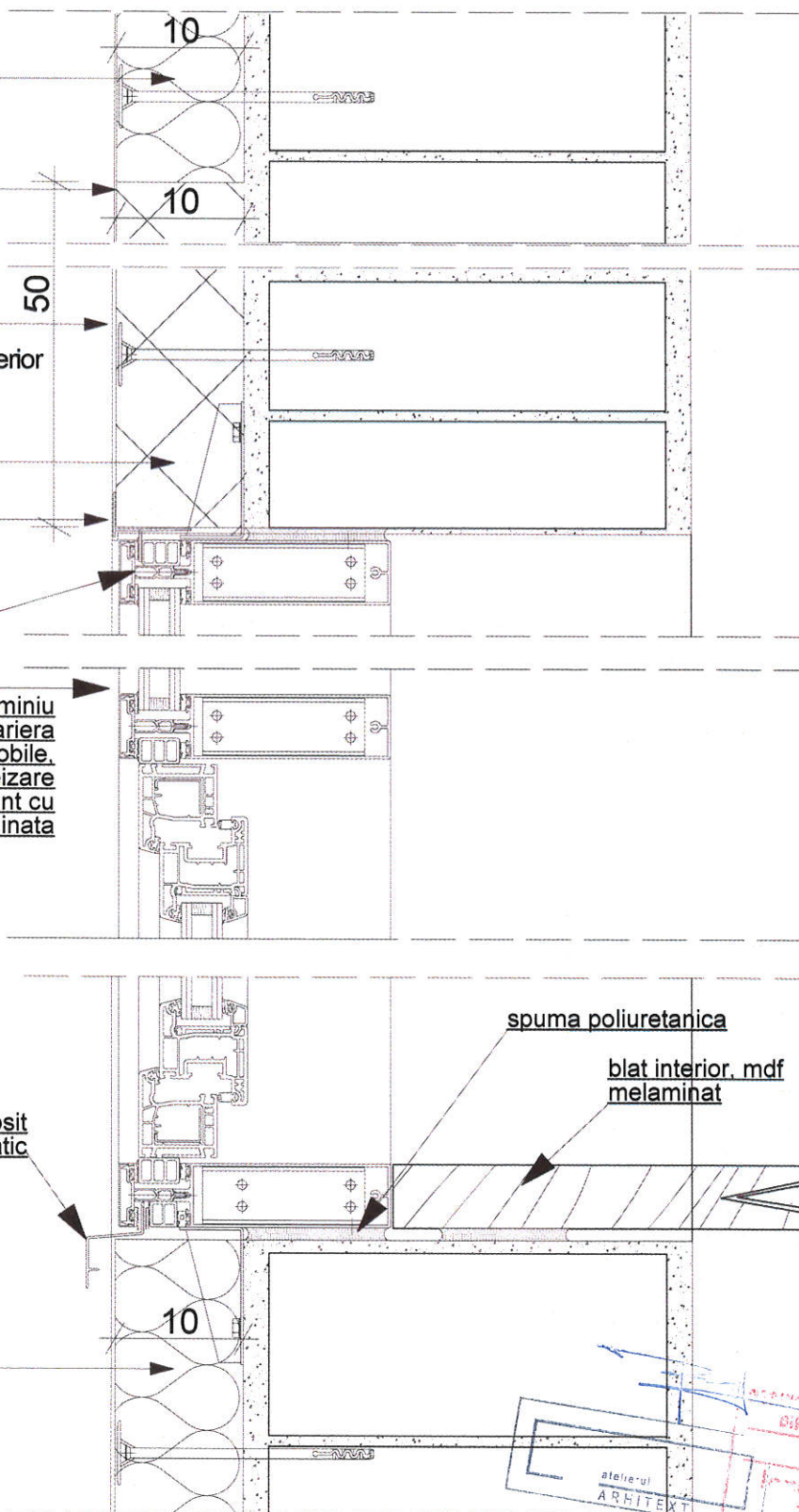

spuma poliuretanică

blat interior, mdf
melaminat

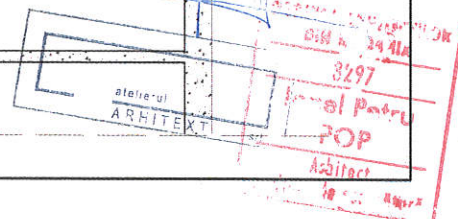

OBIECT 4

DETALII DE EXECUTIE



MODERNIZARE TERASE EXISTENTE,
MONTARE TERMOSISTEM LA FATADE
SI EXTINDERE PE ORIZONTALA CU
CORPURI CONSTRUCTIE D SI E IN
REGIM P+2E+Er LA SCOALA
GIMNAZIALA NR. 30

BENEFICIAR:
SCOALA GIMNAZIALA NR.30 TIMISOARA,
STRADA ASTRILOR, NR. 13, TIMISOARA

ARHITECTURA
Faza: AC, PT, DE, LC, CS

27.b. FINISAJE EXTERIOARE TERMOSISTEM SI VOPSELE DECORATIVE CORP E

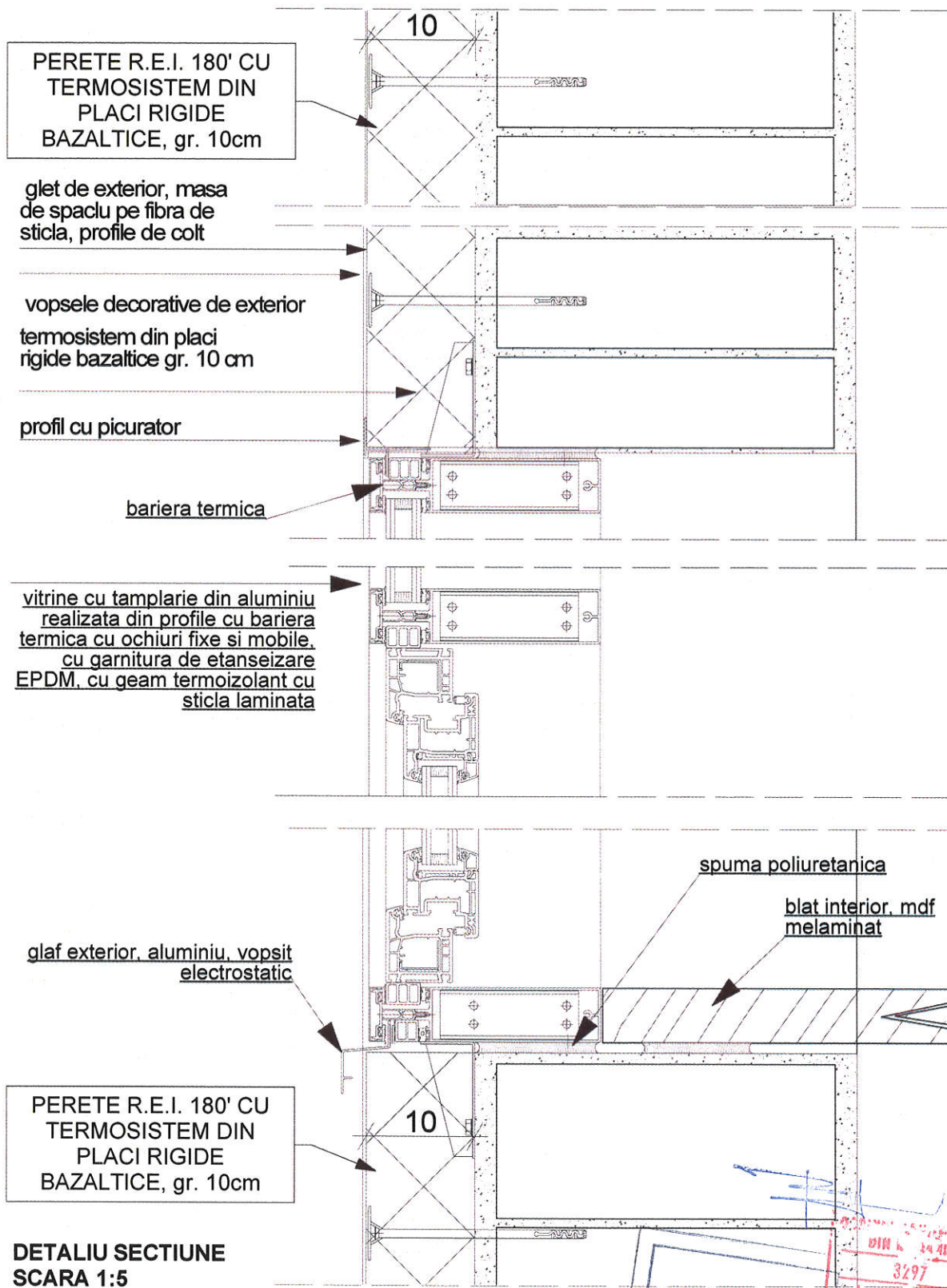

DETALIU SECTIUNE
SCARA 1:5

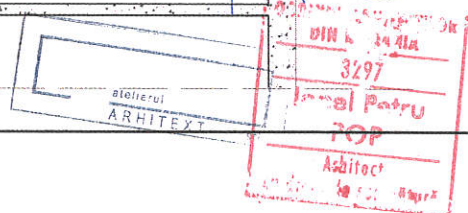

OBIECT 4

DETALII DE EXECUTIE

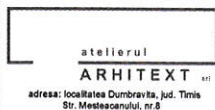

MODERNIZARE TERASE EXISTENTE,
MONTARE TERMOSISTEM LA FATADE
SI EXTINDERE PE ORIZONTALA CU
CORPURI CONSTRUCTIE D SI E IN
REGIM P+2E+Er LA SCOALA
GIMNAZIALA NR. 30

BENEFICIAR:
SCOALA GIMNAZIALA NR.30 TIMISOARA,
STRADA ASTRILOR, NR. 13, TIMISOARA

ARHITECTURA
Faza: AC, PT, DE, LC, CS

28. PLACAJE DIN FOI DE ALUMINIU COMPOZIT LA PARTER CORP E

DETALIU PLAN -PROPUS
SCARA 1:5

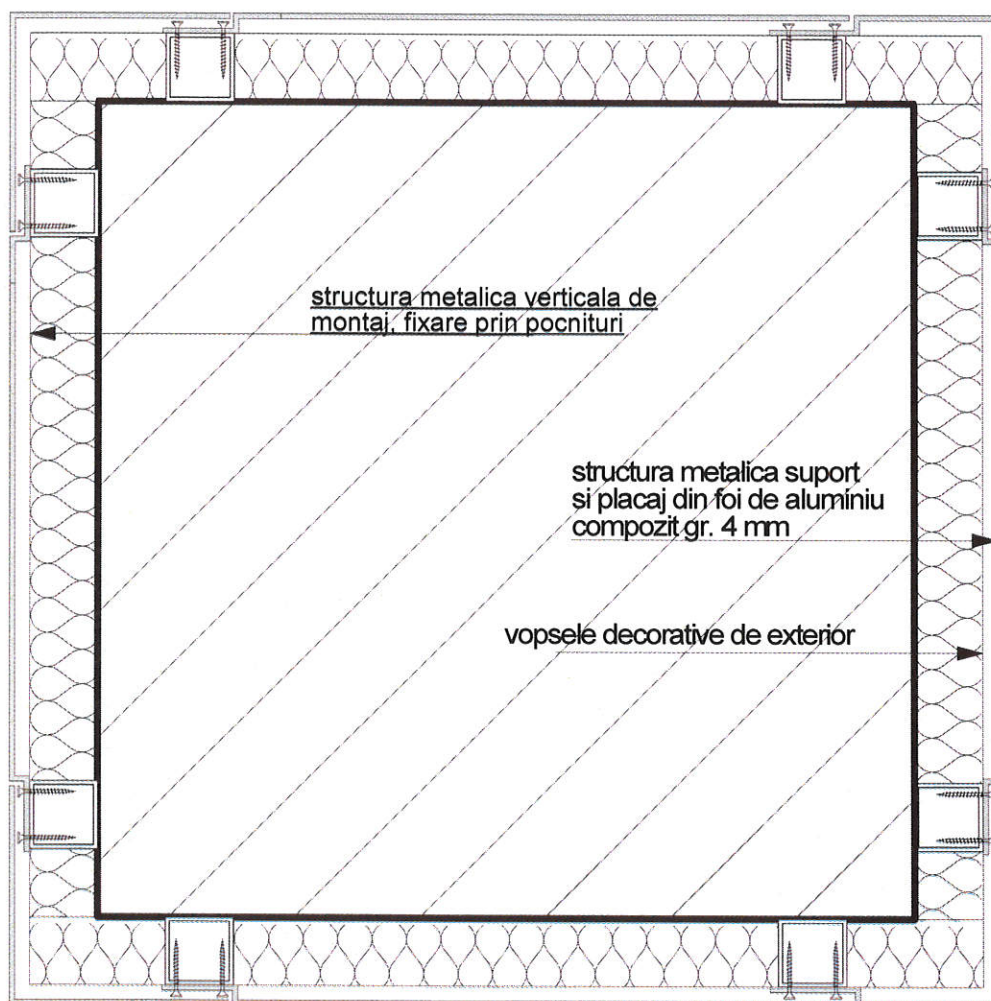

DETALIU SECTIUNE
SCARA 1:5

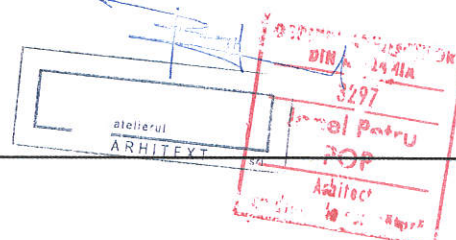

OBIECT 4

DETALII DE EXECUTIE

atelierul
ARHITEXT srl
adresa: localitatea Dumbravita, jud. Timis
Str. Mesteacanului, nr.8

MODERNIZARE TERASE EXISTENTE,
MONTARE TERMOSISTEM LA FATADE
SI EXTINDERE PE ORIZONTALA CU
CORPURI CONSTRUCTIE D SI E IN
REGIM P+2+Er LA SCOALA
GIMNAZIALA NR. 30

BENEFICIAR:
SCOALA GIMNAZIALA NR.30 TIMISOARA,
STRADA ASTRILOR, NR. 13, TIMISOARA
ARHITECTURA
Faza: AC, PT, DE, LC, CS

29. FINISAJE EXTERIOARE TERMOSISTEM SI PLACAJ DIN FOI DE ALUMINIU COMPOZIT CASE DE SCARA

termosistem din placi
de polistiren expandat
grafitat gr. 10 cm

plasa din fibra de sticla si
adeziv pentru spaclu

vopsele decorative de exterior

structura metalica suport
si placaj din foi de aluminiu
compozit gr. 4 mm

termosistem din placi
rigide bazaltice gr. 10 cm

profil cu picurator

termosistem din placi de
polistiren extrudat
grafitat gr. 2 cm

termosistem din placi de
polistiren extrudat
grafitat gr. 2 cm

termosistem din placi
de polistiren expandat
grafitat gr. 10 cm

structura metalica suport
si placaj din foi de aluminiu
compozit gr. 4 mm

DETALIU SECTIUNE
SCARA 1:5

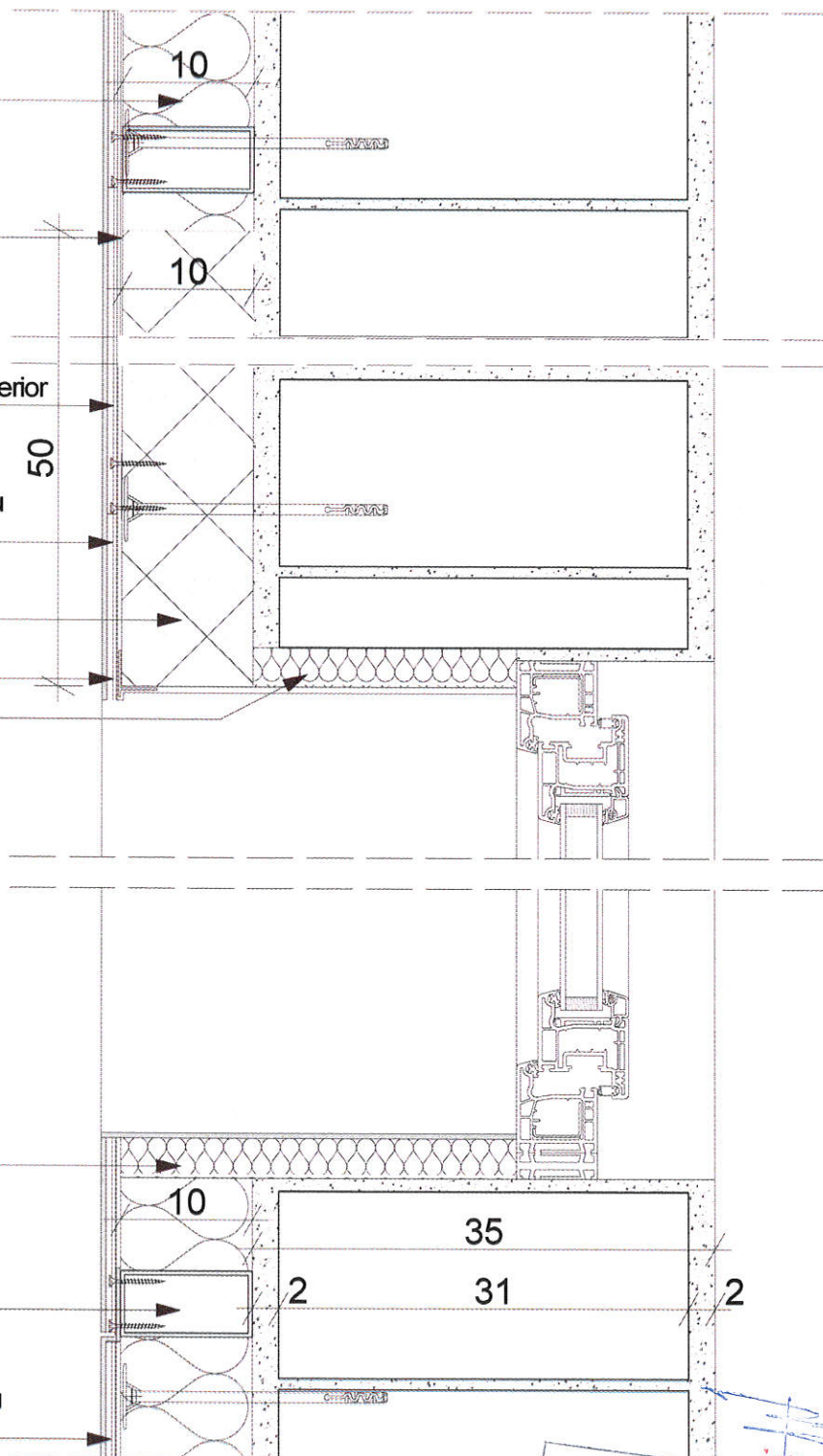

OBIECT 4

DETALII DE EXECUTIE



MODERNIZARE TERASE EXISTENTE,
MONTARE TERMOSISTEM LA FATADE
SI EXTINDERE PE ORIZONTALA CU
CORPURI CONSTRUCTIE D SI E IN
REGIM P+2E+Er LA SCOALA
GIMNAZIALA NR. 30

BENEFICIAR:
SCOALA GIMNAZIALA NR.30 TIMISOARA,
STRADA ASTRILOR, NR. 13, TIMISOARA

ARHITECTURA
Faza: AC, PT, DE, LC, CS

30. BALUSTRADE DE PROTECTIE LA SCARI CORP E

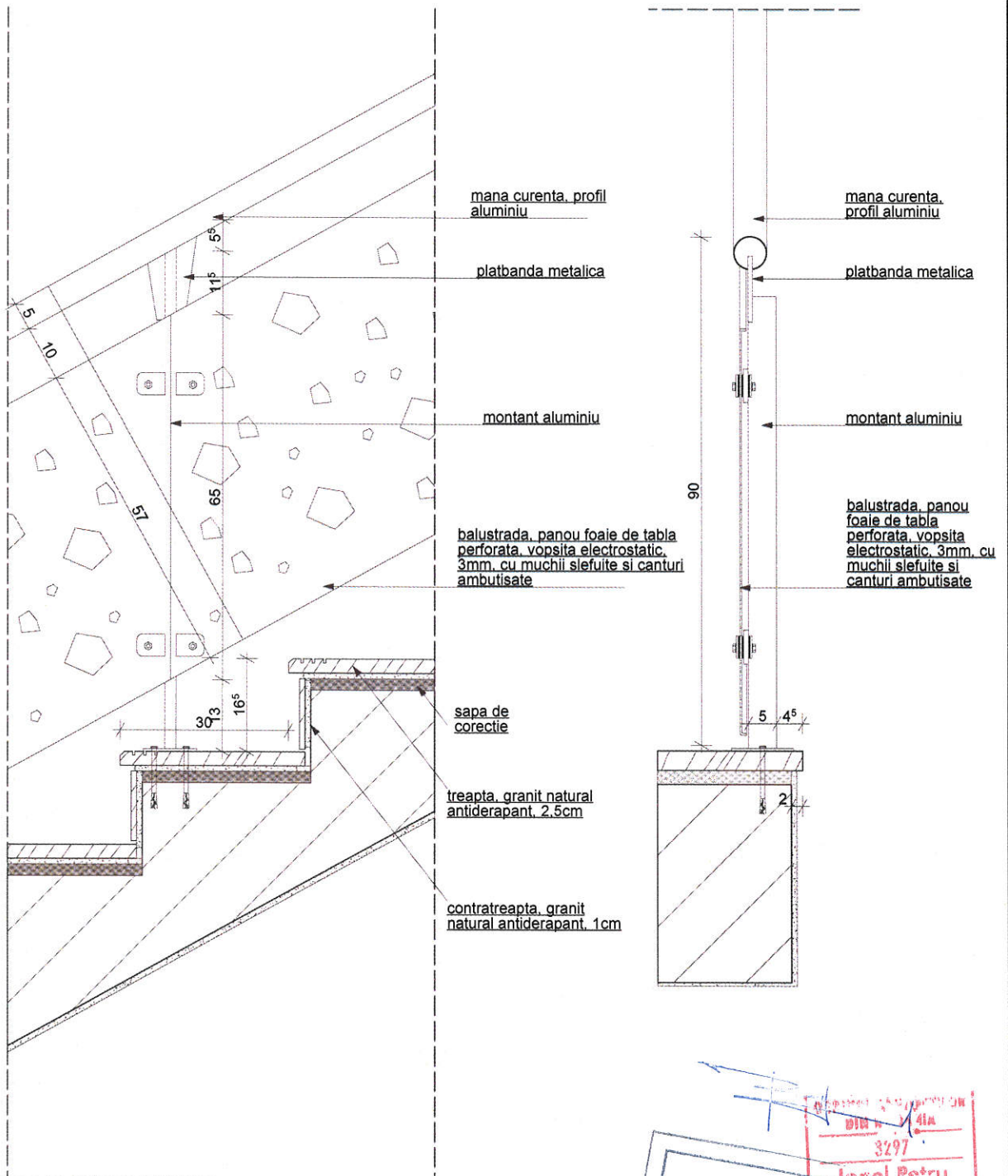

DETALIU SECTIUNE
SCARA 1:10

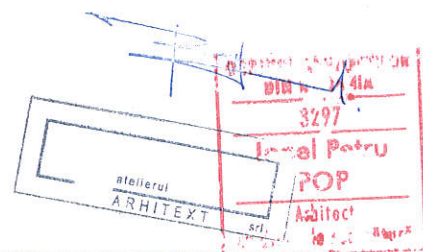

OBIECT 4

DETALII DE EXECUTIE



MODERNIZARE TERASE EXISTENTE,
MONTARE TERMOSISTEM LA FATADE
SI EXTINDERE PE ORIZONTALA CU
CORPURI CONSTRUCTIE D SI E IN
REGIM P+2+Er LA SCOALA
GIMNAZIALA NR. 30

BENEFICIAR:
SCOALA GIMNAZIALA NR.30 TIMISOARA,
STRADA ASTRILOR, NR. 13, TIMISOARA

ARHITECTURA
Faza: AC, PT, DE, LC, CS

31. IZOLATII SI FINISAJE LA PERTI DE INCHIDERE SUB PARTER CORP E

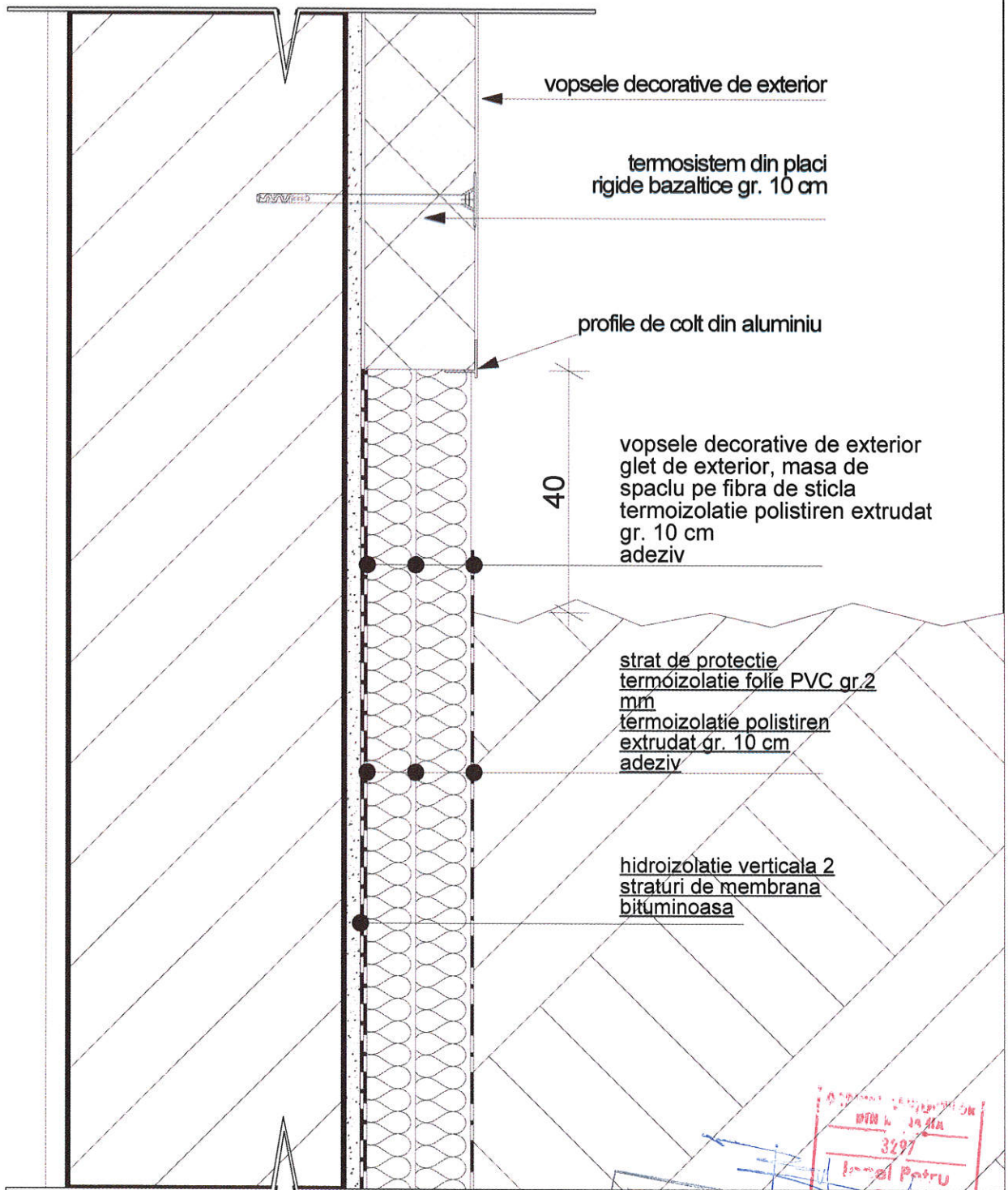

DETALIU SECTIUNE
SCARA 1:5

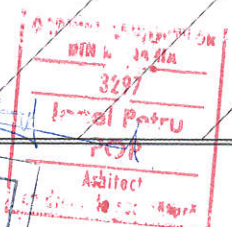

OBIECT 4

DETALII DE EXECUTIE



MODERNIZARE TERASE EXISTENTE,
MONTARE TERMOSISTEM LA FATADE
SI EXTINDERE PE ORIZONTALA CU
CORPURI CONSTRUCTIE D SI E IN
REGIM P+2E+Er LA SCOALA
GIMNAZIALA NR. 30

BENEFICIAR:
SCOALA GIMNAZIALA NR.30 TIMISOARA,
STRADA ASTRILOR, NR. 13, TIMISOARA

ARHITECTURA
Faza: AC, PT, DE, LC, CS

32. PERETI SI FINISAJE EXTERIOARE LA ATICE CORP E

agrafa metalica din platbanda
glaf din tabla vopsit electrostatic

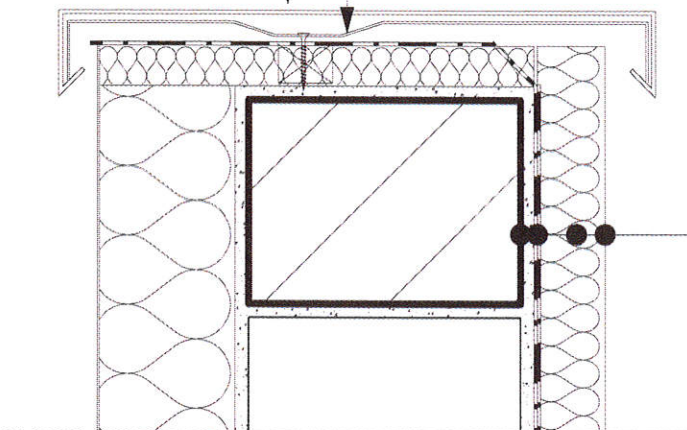

perete din zidarie din blocuri
ceramice cu goluri
tencuiala 1 strat: grunt
suport hidroizolatie verticala
amorsa
strat DDC
hidroizolatie verticala 2
straturi membrana
bituminoasa
(racordata la hidroizolatia
orizontala terasa)
adeziv
termoizolatie polistiren
expandat gr. 5 cm
glet de exterior, masa
de spaclu pe fibra de sticla,
profile de colt
vopsele decorative

termosistem
din placi de
polistiren
expandat
grafitat gr. 10
cm

glet de
exterior, masa
de spaclu pe
fibra de sticla,
profile de colt

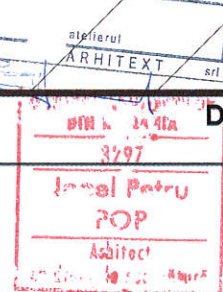
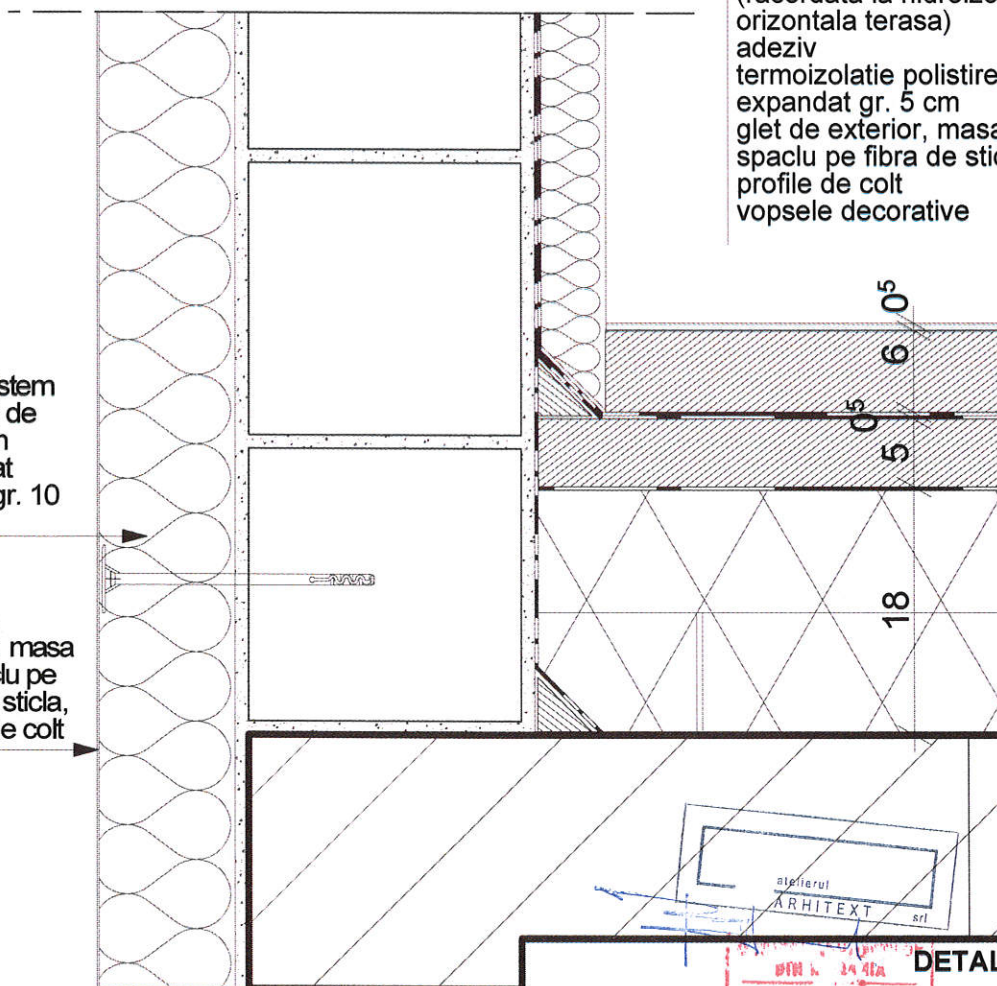

DETALIU SECTIUNE
SCARA 1:5

OBIECT 4

DETALII DE EXECUTIE



MODERNIZARE TERASE EXISTENTE,
MONTARE TERMOSISTEM LA FATADE
SI EXTINDERE PE ORIZONTALA CU
CORPURI CONSTRUCTIE D SI E IN
REGIM P+2E+Er LA SCOALA
GIMNAZIALA NR. 30

BENEFICIAR:
SCOALA GIMNAZIALA NR.30 TIMISOARA,
STRADA ASTRILOR, NR. 13, TIMISOARA

ARHITECTURA
Faza: AC, PT, DE, LC, CS

33. FINISAJE LA ANCADRAMENTE IN CONSOLA FATADE CORP E

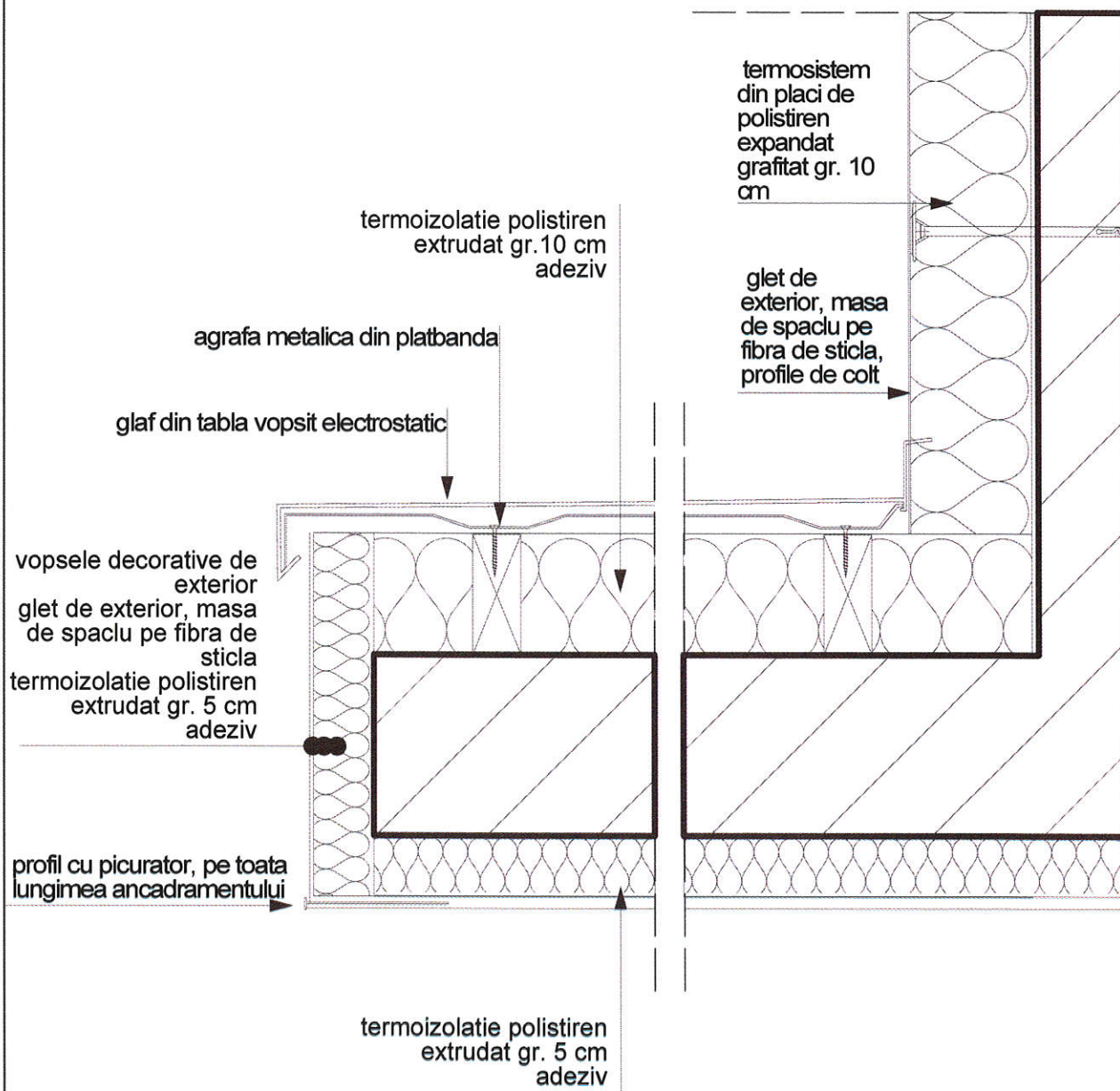

DETALIU SECTIUNE
SCARA 1:5

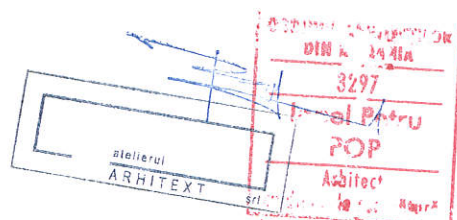

OBIECT 4
DETALII DE EXECUTIE

atelierul
ARHITEXT srl
adresa: localitatea Dumbravita, jud. Timis
Str. Mesteacanului, nr. 8

MODERNIZARE TERASE EXISTENTE,
MONTARE TERMOSISTEM LA FATADE
SI EXTINDERE PE ORIZONTALA CU
CORPURI CONSTRUCTIE D SI E IN
REGIM P+2E+Er LA SCOALA
GIMNAZIALA NR. 30

BENEFICIAR:
SCOALA GIMNAZIALA NR.30 TIMISOARA,
STRADA ASTRILOR, NR. 13, TIMISOARA

ARHITECTURA
Faza: AC, PT, DE, LC, CS

34. TAMPLARII INTERIOARE CORP D

DETALIU SECTIUNE
SCARA 1:5

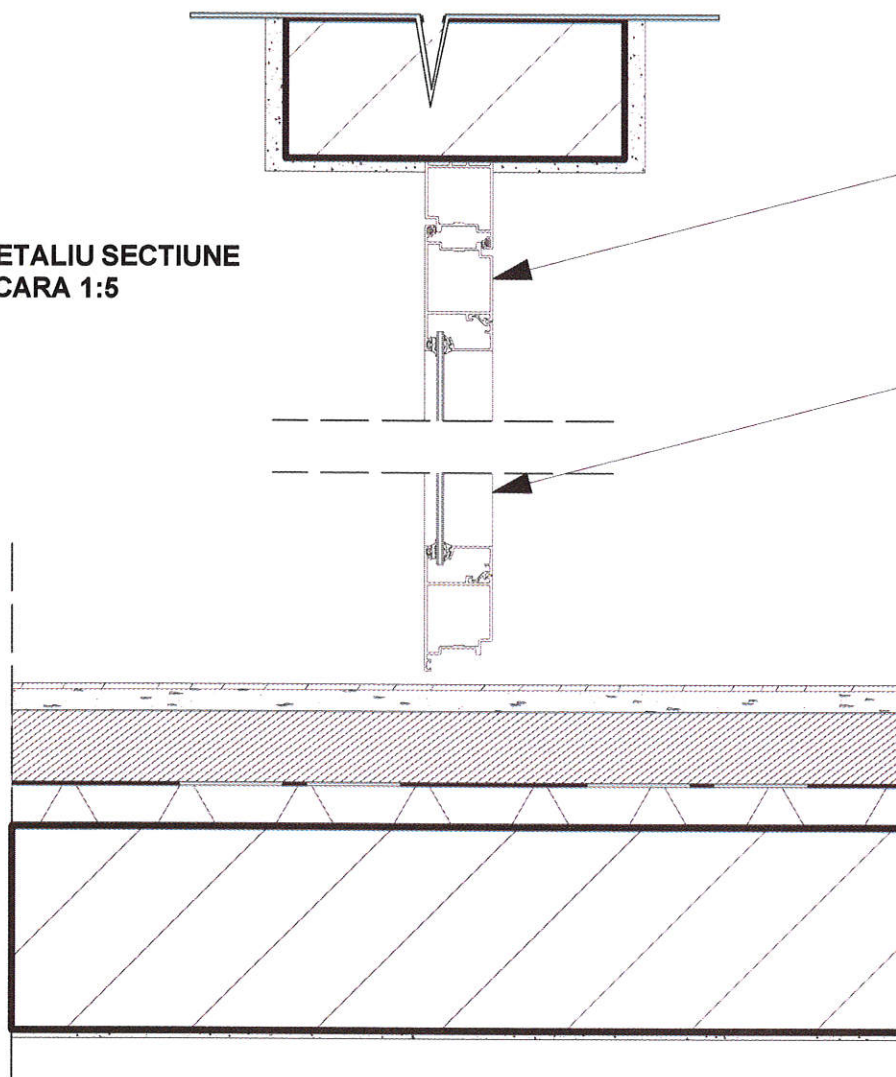

tamplarie din
aluminiu
realizata cu
garnitura de
etanseizare

geam cu sticla
3-1-3 laminata
clara

DETALIU PLAN
SCARA 1:5

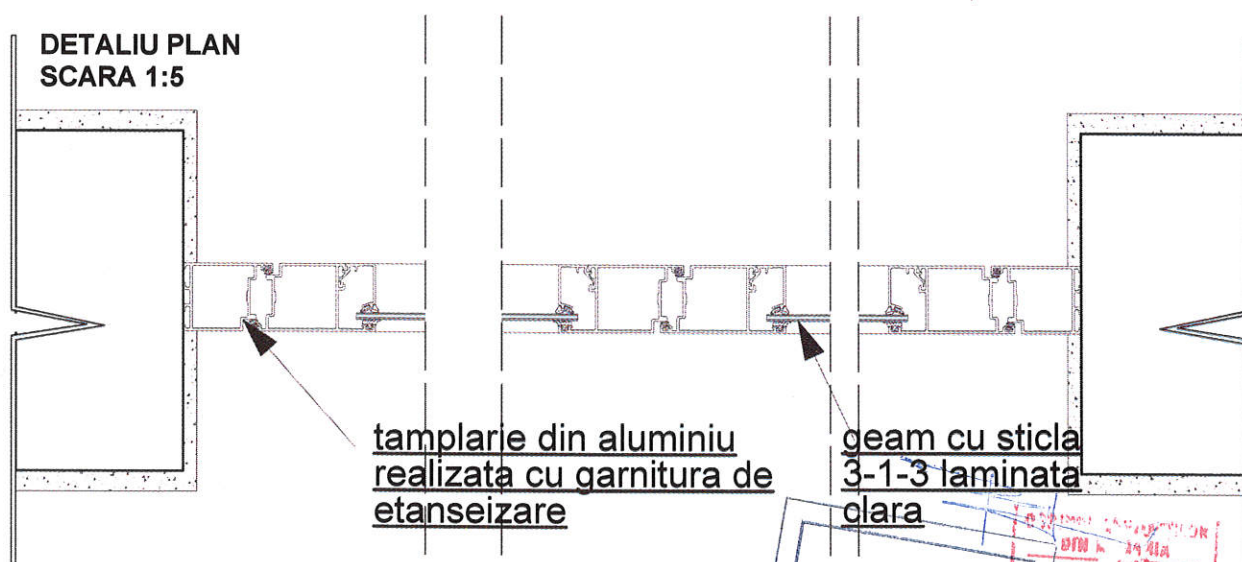

tamplarie din aluminiu
realizata cu garnitura de
etanseizare

geam cu sticla
3-1-3 laminata
clara

atelierul
ARHITEXT srl
3297
POP
Arhitect

OBIECT 4

DETALII DE EXECUTIE

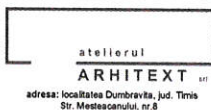

MODERNIZARE TERASE EXISTENTE,
MONTARE TERMOSISTEM LA FATADE
SI EXTINDERE PE ORIZONTALA CU
CORPURI CONSTRUCTIE D SI E IN
REGIM P+2E+Er LA SCOALA
GIMNAZIALA NR. 30

BENEFICIAR:
SCOALA GIMNAZIALA NR.30 TIMISOARA,
STRADA ASTRILOR, NR. 13, TIMISOARA

ARCHITECTURA
Faza: AC, PT, DE, LC, CS

35. TAMPLARII EXTERIOARE CORP D

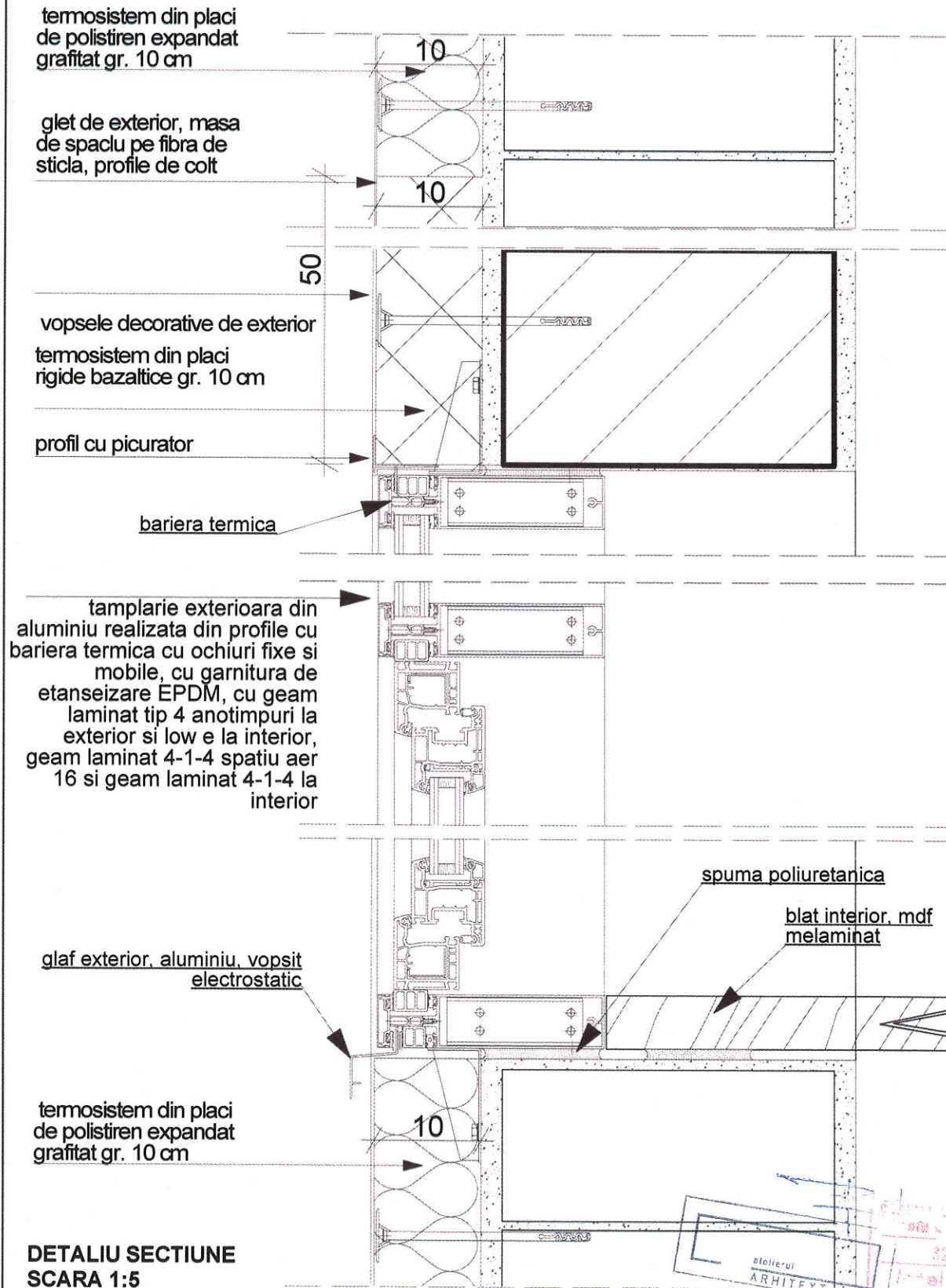

atelierul
ARHITEX SRL

3297

POP

OBIECT 4

DETALII DE EXECUTIE

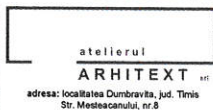

MODERNIZARE TERASE EXISTENTE,
MONTARE TERMOSISTEM LA FATADE
SI EXTINDERE PE ORIZONTALA CU
CORPURI CONSTRUCTIE D SI E IN
REGIM P+2E+Er LA SCOALA
GIMNAZIALA NR. 30

BENEFICIAR:
SCOALA GIMNAZIALA NR.30 TIMISOARA,
STRADA.ASTRILOR, NR. 13, TIMISOARA

ARHITECTURA
Faza: AC, PT, DE, LC, CS

36. PROFILE DE TRECERE INTRE PARDOSELI

cover PVC gr 4 mm
adeziv
sapa autonivelanta
amorsa
sapa incalzire pardoseala, gr 6 cm
folie PVC gr. 2mm
teava incalzire in pardoseala 17mm
inglobata in izolatia polistiren
extrudat, placa cu nuturi, 3cm
termoizolatie placi polistiren extrudat
gr. 17 cm
suport, placa B.A.

placi din parchet lamelar de lemn
stratificat, gr.2cm
folie polietilena expandata, gr.
3mm
amorsa
sapa slab-armata gr 5 cm
folie PVC gr. 2mm
dala flotanta polistiren extrudat,
gr.3 cm
placa, B.A., 15 cm
finisaj interior, tencuiala

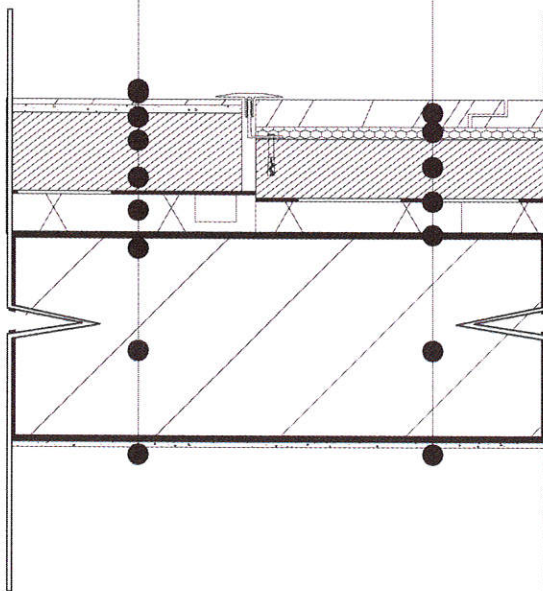

DETALIU SECTIUNE
SCARA 1:5



OBIECT 4

DETALII DE EXECUTIE



MODERNIZARE TERASE EXISTENTE,
MONTARE TERMOSISTEM LA FATADE
SI EXTINDERE PE ORIZZONTALA CU
CORPURI CONSTRUCTIE D SI E IN
REGIM P+2E+Er LA SCOALA
GIMNAZIALA NR. 30

BENEFICIAR:
SCOALA GIMNAZIALA NR.30 TIMISOARA,
STRADA ASTRILOR, NR. 13, TIMISOARA

ARHITECTURA
Faza: AC, PT, DE, LC, CS

37. PROFILE PENTRU ROSTURI DE DILATATIE LA PARDOSELI

DETALIU SECTIUNE
SCARA 1:5

placi de granit natural antiderapant gr. 1,5 cm
adeziv
amorsa
hidroizolatie flexibila tip flusigfolie cu banda de colt gr. 2 mm
amorsa
sapa incalzire pardoseala, gr 5 cm
folie PVC gr. 2mm
teava incalzire in pardoseala 17mm inglobata in izolatie polistiren extrudat, placa cu nuturi, 3cm
placa, B.A., 15 cm

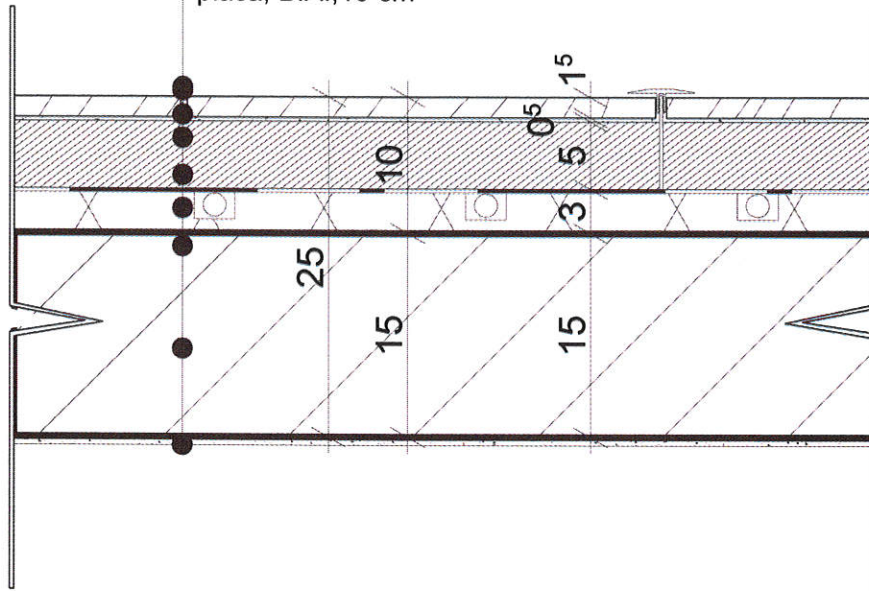

 - profilul, dilatat

 - profilul, comprimat

 - profilul, denivelat

- varianta perete - pardoseala

C.1

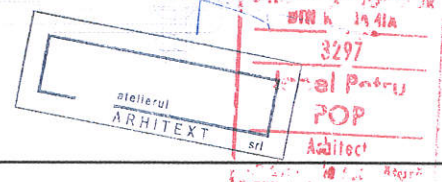

OBIECT 4

DETALII DE EXECUTIE



MODERNIZARE TERASE EXISTENTE,
MONTARE TERMOSISTEM LA FATADE
SI EXTINDERE PE ORIZONTALA CU
CORPURI CONSTRUCTIE D SI E IN
REGIM P+2+Er LA SCOALA
GIMNAZIALA NR. 30

BENEFICIAR:
SCOALA GIMNAZIALA NR.30 TIMISOARA,
STRADA ASTRILOR, NR. 13, TIMISOARA

ARHITECTURA
Faza: AC, PT, DE, LC, CS

38. PROFILE PENTRU ROSTURI DE DILATATIE CONSTRUCTIVE

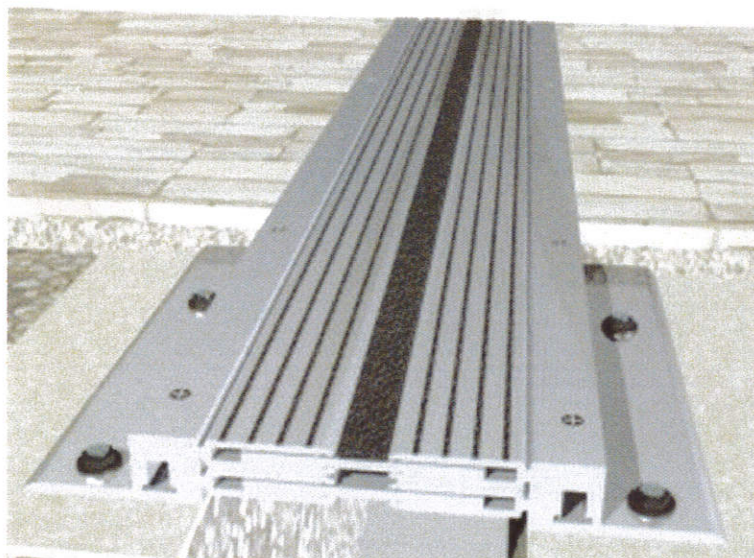

LUNGIME DILATATIE

40(+ -20)
100(+ -50)
120(+ -60)
150(+ -75)

MATERIALE

Aluminiu Fisa
tehnica
profil
dilatatie
seismic
pardoseala
seria
820RS

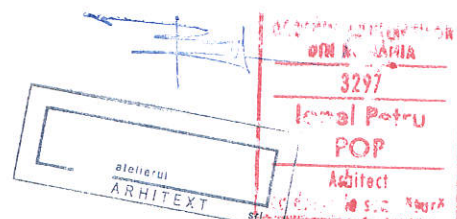

OBIECT 4

DETALII DE EXECUTIE



MODERNIZARE TERASE EXISTENTE,
MONTARE TERMOSISTEM LA FATADE
SI EXTINDERE PE ORIZONTALA CU
CORPURI CONSTRUCTIE D SI E IN
REGIM P+2+Er LA SCOALA
GIMNAZIALA NR. 30

BENEFICIAR:
SCOALA GIMNAZIALA NR.30 TIMISOARA,
STRADA ASTRILOR, NR. 13, TIMISOARA

ARHITECTURA
Faza: AC, PT, DE, LC, CS

39. DREN PERIMETRAL

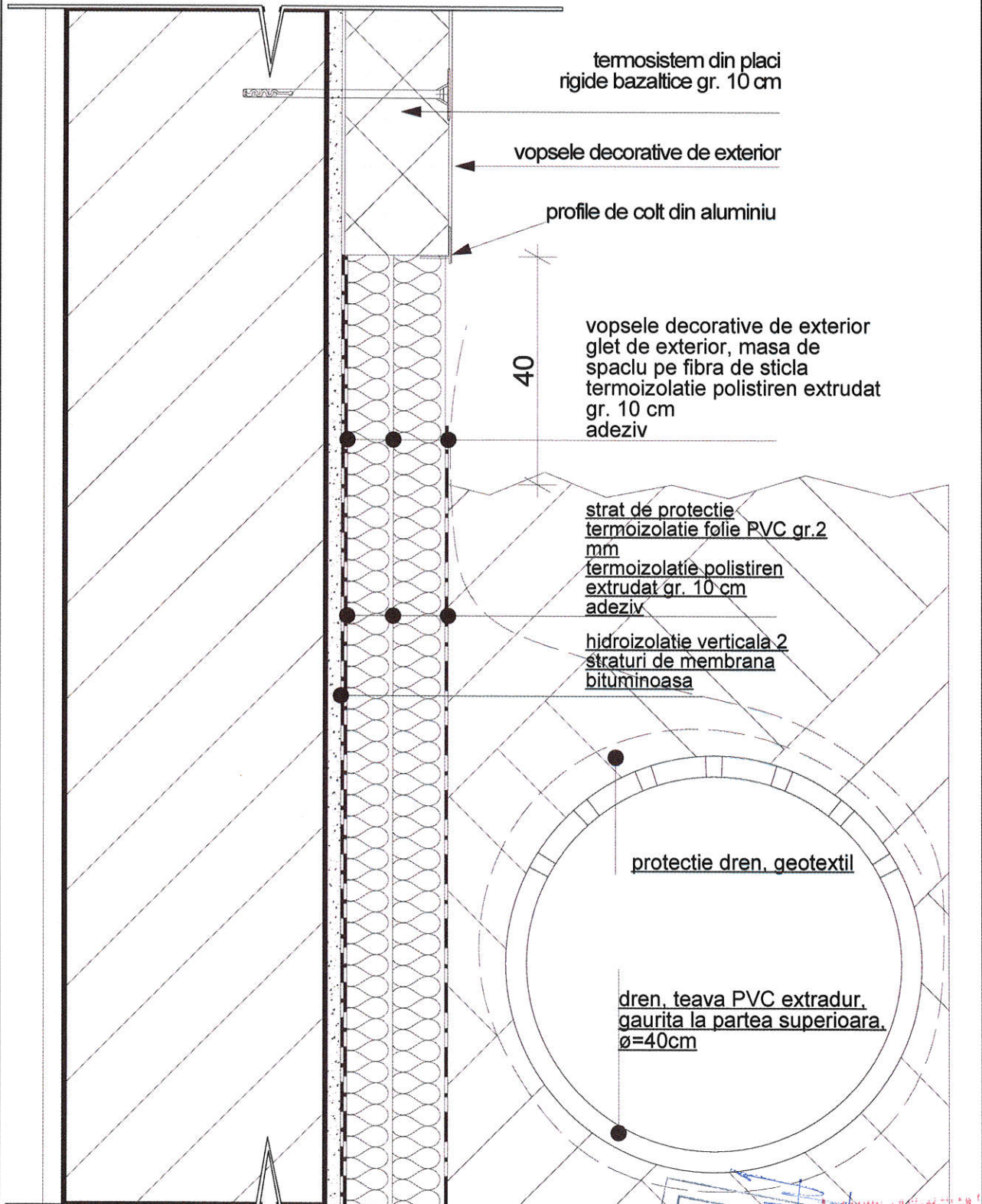

DETALIU SECTIUNE
SCARA 1:5

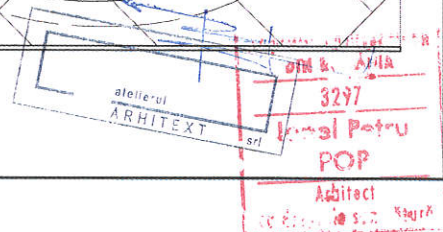

OBIECT 4

DETALII DE EXECUTIE



MODERNIZARE TERASE EXISTENTE,
MONTARE TERMOSISTEM LA FATADE
SI EXTINDERE PE ORIZONTALA CU
CORPURI CONSTRUCTIE D SI E IN
REGIM P+2E+Er LA SCOALA
GIMNAZIALA NR. 30

BENEFICIAR:
SCOALA GIMNAZIALA NR.30 TIMISOARA,
STRADA ASTRILOR, NR. 13, TIMISOARA

ARHITECTURA
Faza: AC, PT, DE, LC, CS

41. GLAFURI INTERIOARE LA FERESTRE

termosistem din placi
de polistiren expandat
grafitat gr. 10 cm

glet de exterior, masa
de spaclu pe fibra de
sticla, profile de colt

vopsele decorative de exterior
termosistem din placi
rigide bazaltice gr. 10 cm

profil cu picurator

bariera termica

tamplarie exterioara din aluminiu realizata din
profile cu bariera termica cu ochiuri fixe si
mobile, cu garnitura de etanseizare EPDM, cu
geam laminat tip 4 anotimpuri la exterior si low e
la interior, geam laminat 4-1-4 spatiu aer 16 si
geam laminat 4-1-4 la interior

glaf exterior, aluminiu, vopsit
electrostatic

termosistem din placi
de polistiren expandat
grafitat gr. 10 cm

DETALIU SECTIUNE
SCARA 1:5

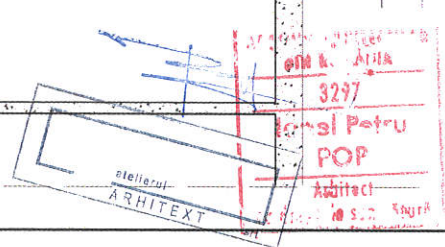
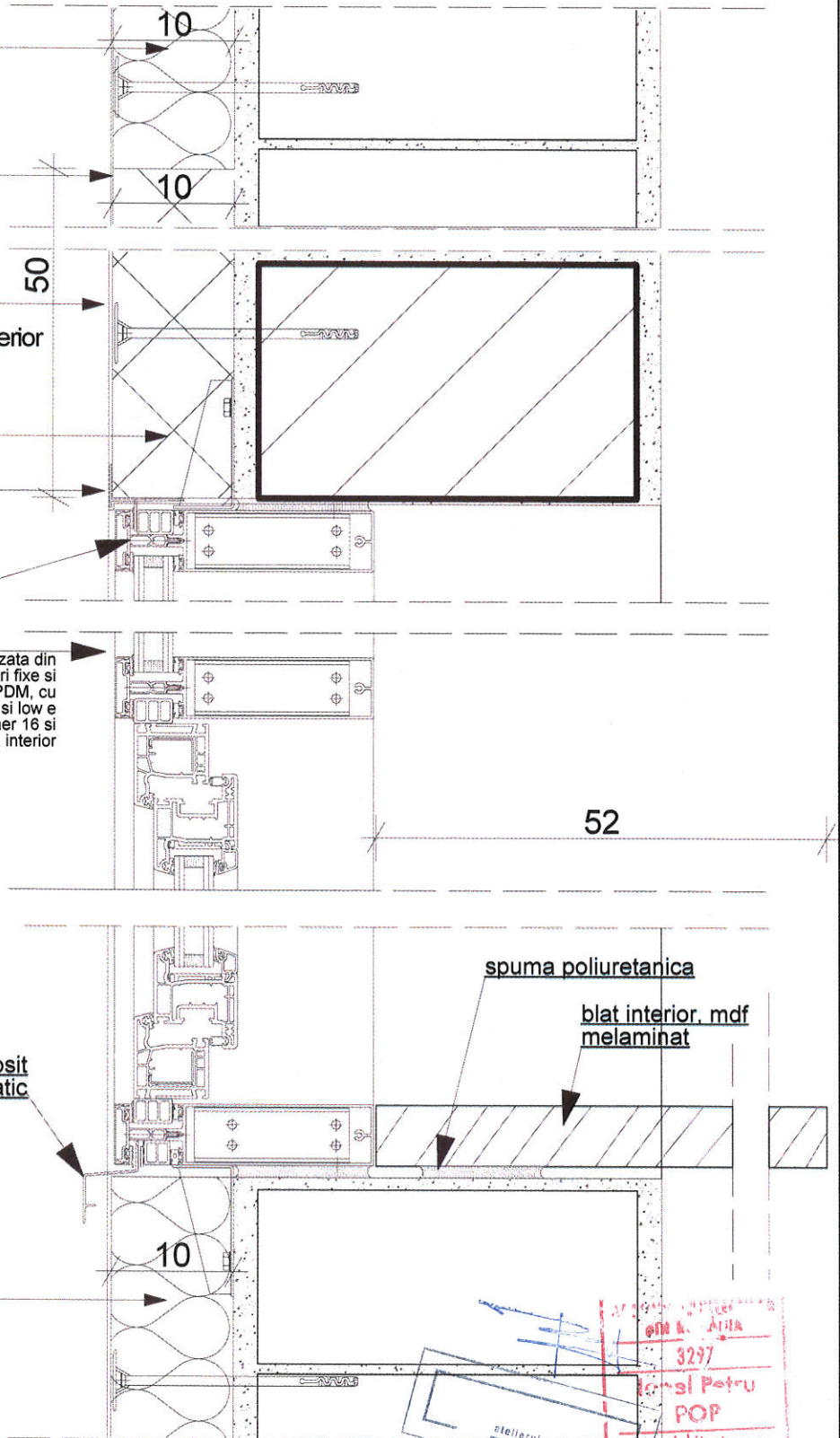

OBIECT 4

DETALII DE EXECUTIE



MODERNIZARE TERASE EXISTENTE,
MONTARE TERMOSISTEM LA FATADE
SI EXTINDERE PE ORIZONTALA CU
CORPURI CONSTRUCTIE D SI E IN
REGIM P+2+Er LA SCOALA
GIMNAZIALA NR. 30

BENEFICIAR:
SCOALA GIMNAZIALA NR.30 TIMISOARA,
STRADA ASTRILOR, NR. 13, TIMISOARA

ARHITECTURA
Faza: AC, PT, DE, LC, CS

42. GLAFURI EXTERIOARE LA FERESTRE

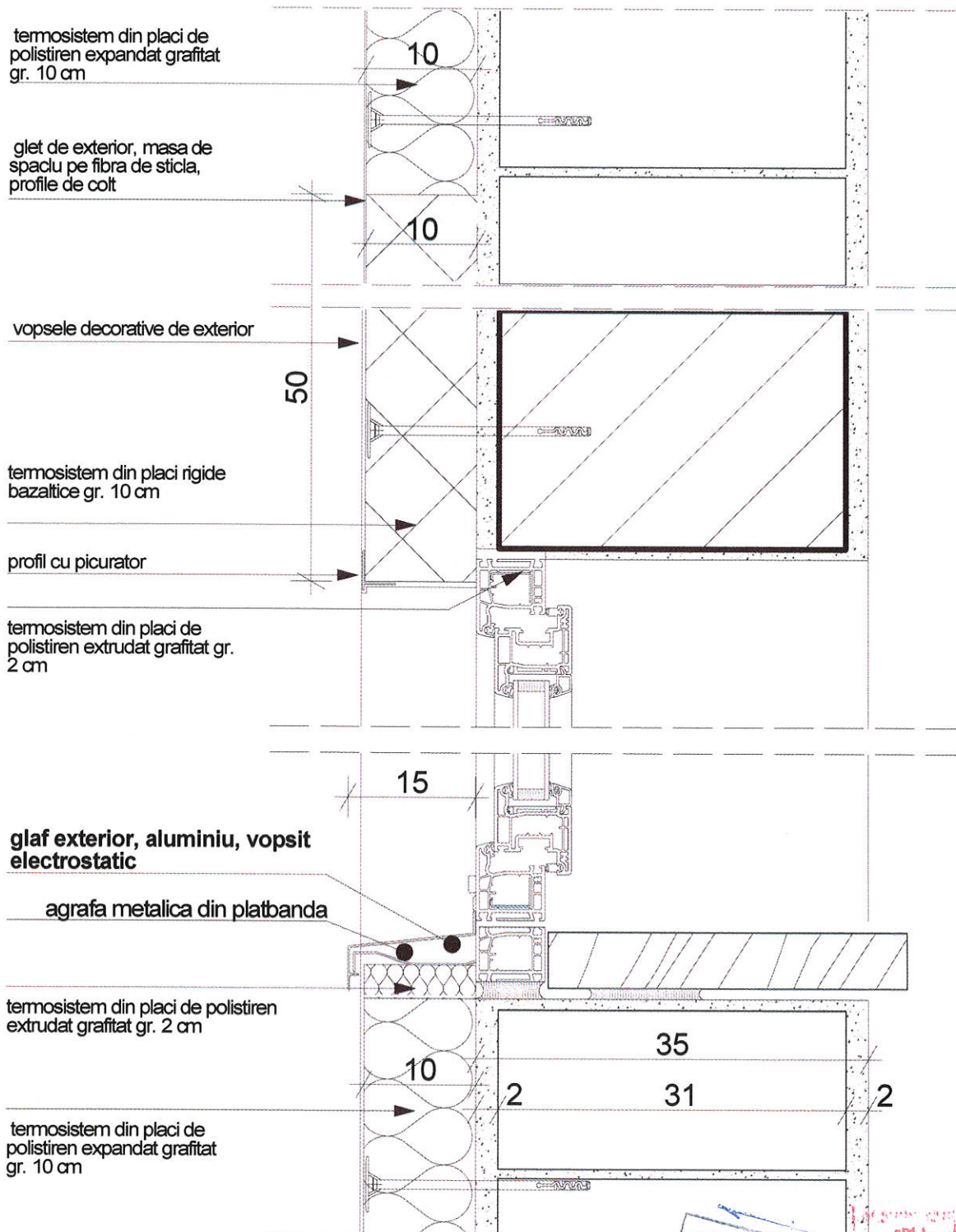

DETALIU SECTIUNE
SCARA 1:5

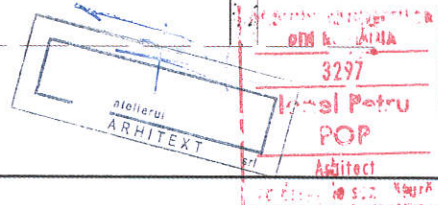

OBIECT 4

DETALII DE EXECUTIE

atelierul
ARHITEXT srl
adresa: localitatea Dumbravita, jud. Timis
Str. Mesteacanului, nr.8

MODERNIZARE TERASE EXISTENTE,
MONTARE TERMOSISTEM LA FATADE
SI EXTINDERE PE ORIZONTALA CU
CORPURI CONSTRUCTIE D SI E IN
REGIM P+2E+Er LA SCOALA
GIMNAZIALA NR. 30

BENEFICIAR:
SCOALA GIMNAZIALA NR.30 TIMISOARA,
STRADA ASTRILOR, NR. 13, TIMISOARA
ARHITECTURA
Faza: AC, PT, DE, LC, CS

43. BRISESOLEIURI ORIZONTALE

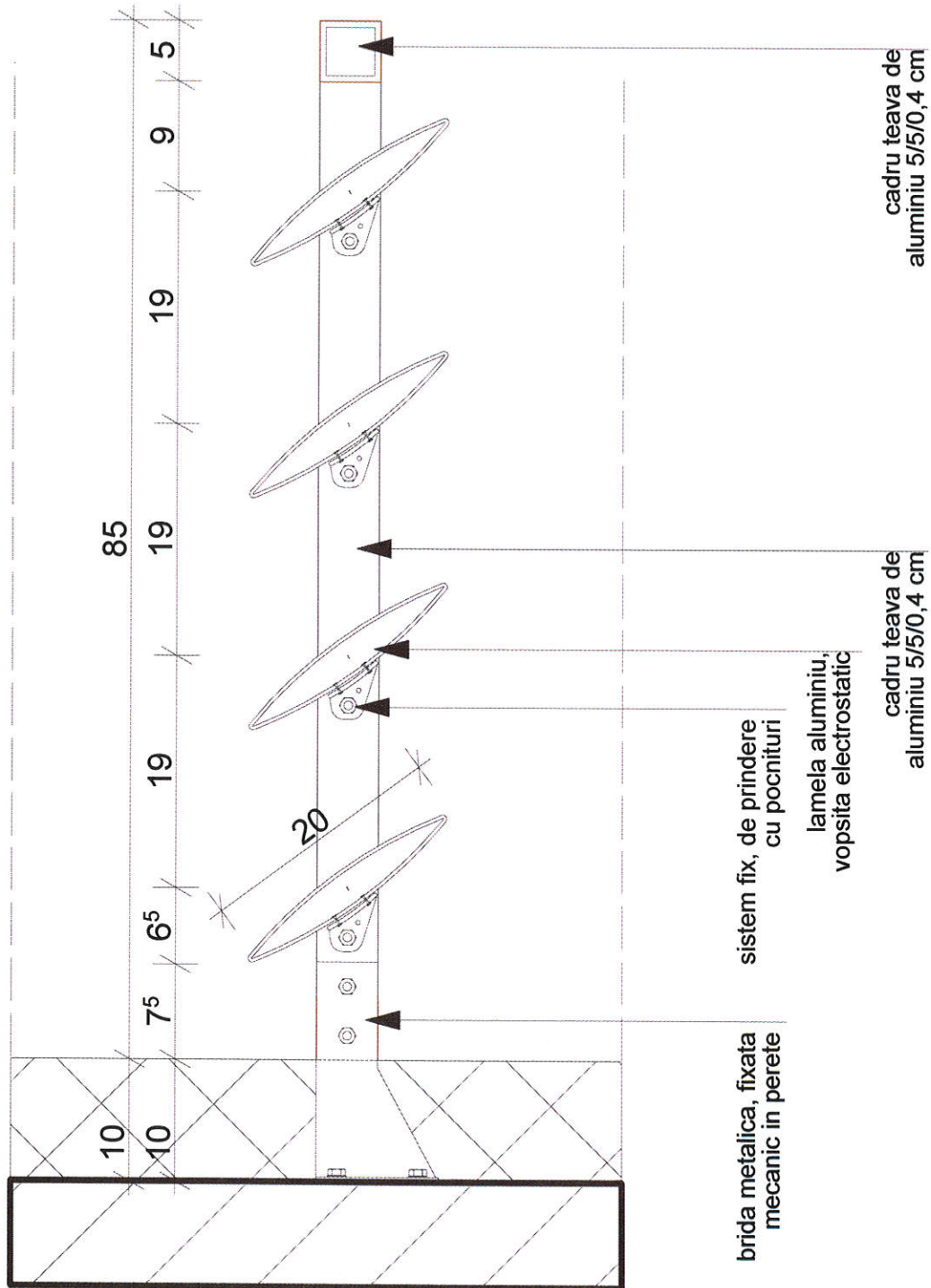

3297
Ing. Petru POP
Arhitect
atelierul
ARHITEXT srl

DETALIU SECTIUNE
SCARA 1:5

OBIECT 4
DETALII DE EXECUTIE

atelierul
ARHITEXT srl
adresa: localitatea Dumbravita, jud. Timis
Str. Mesteacanului, nr.8

MODERNIZARE TERASE EXISTENTE,
MONTARE TERMOSISTEM LA FATADE
SI EXTINDERE PE ORIZONTALA CU
CORPURI CONSTRUCTIE D SI E IN
REGIM P+2E+Er LA SCOALA
GIMNAZIALA NR. 30

BENEFICIAR:
SCOALA GIMNAZIALA NR.30 TIMISOARA,
STRADA ASTRILOR, NR. 13, TIMISOARA
ARHITECTURA
Faza: AC, PT, DE, LC, CS

44. COPERTINA USA ETAJ 2 ACCES TERASA

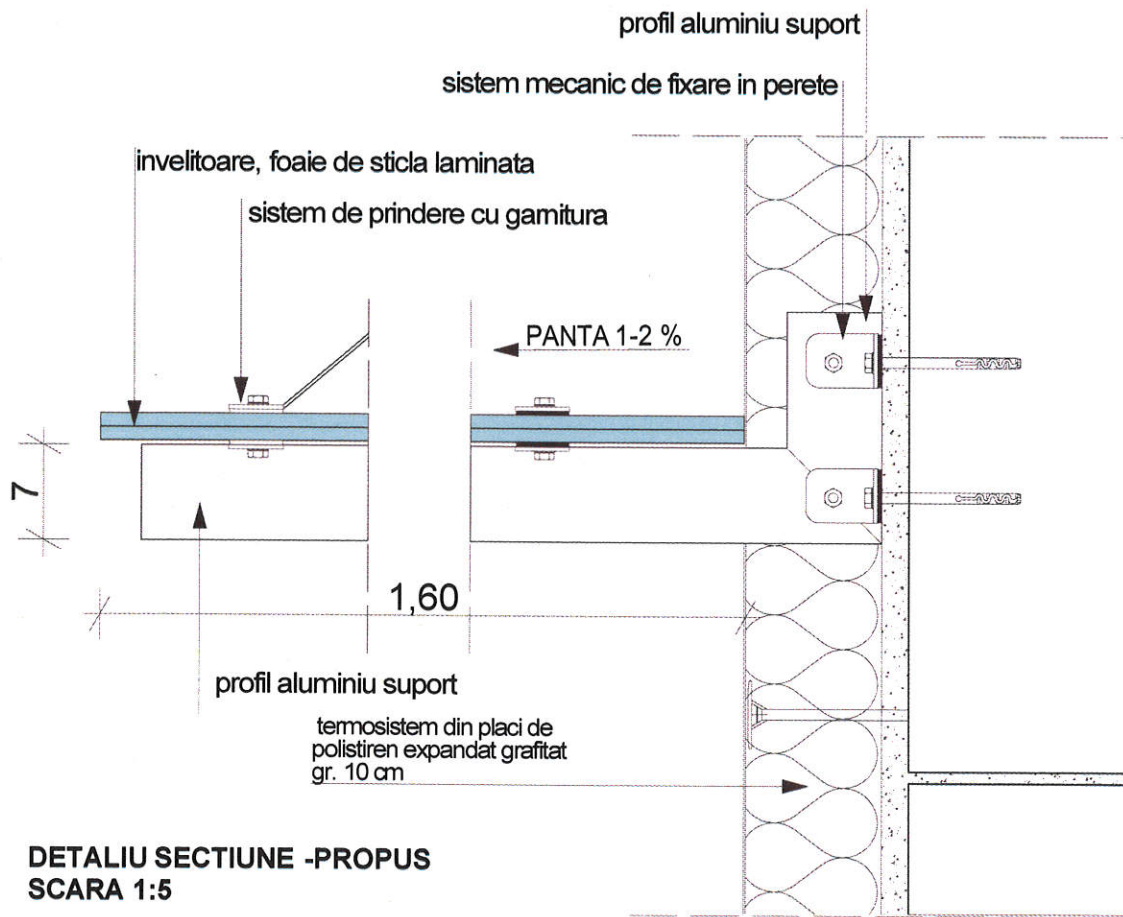

DETALIU SECTIUNE -PROPUS
SCARA 1:5

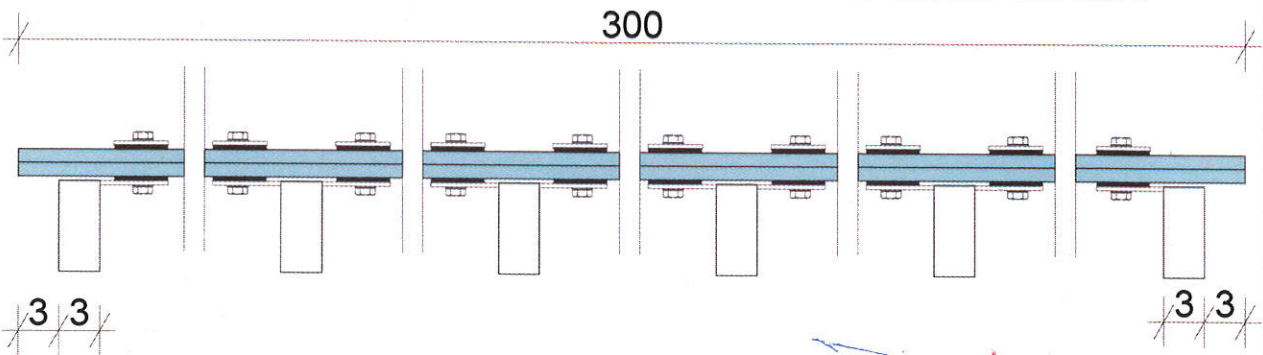

DETALIU VEDERE
SCARA 1:5

atelierul
ARHITEXT srl

PROIECT DE ARHITECTURA
SINTEZA
3297
Ionel Patru
POP
Arhitect

OBIECT 4
DETALII DE EXECUTIE

atelierul
ARHITEXT srl
adresa: localitatea Dumbravita, jud. Timis
Str. Mesteacanului, nr.8

**MODERNIZARE TERASE EXISTENTE,
MONTARE TERMOSISTEM LA FATADE
SI EXTINDERE PE ORIZONTALA CU
CORPURI CONSTRUCTIE D SI E IN
REGIM P+2E+Er LA SCOALA
GIMNAZIALA NR. 30**

BENEFICIAR:
SCOALA GIMNAZIALA NR.30 TIMISOARA,
STRADA ASTRILOR, NR. 13, TIMISOARA
ARHITECTURA
Faza: AC, PT, DE, LC, CS

45. IMPREJMUIRE METALICA

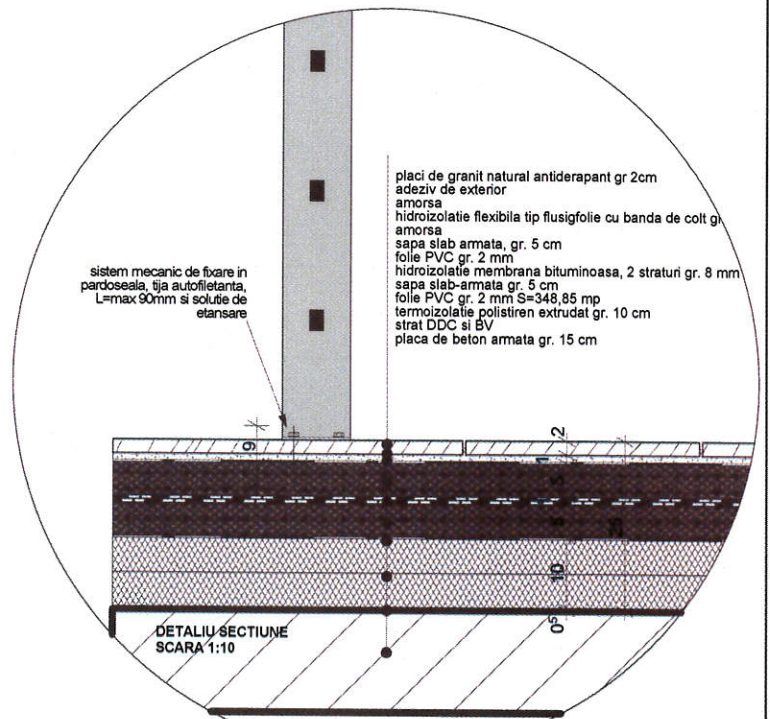
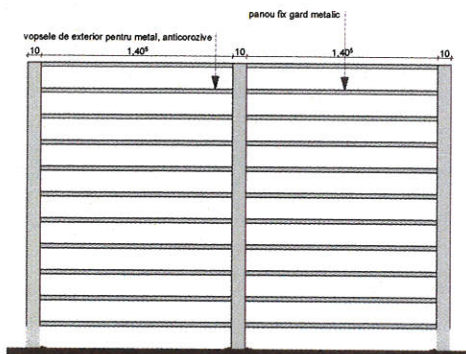
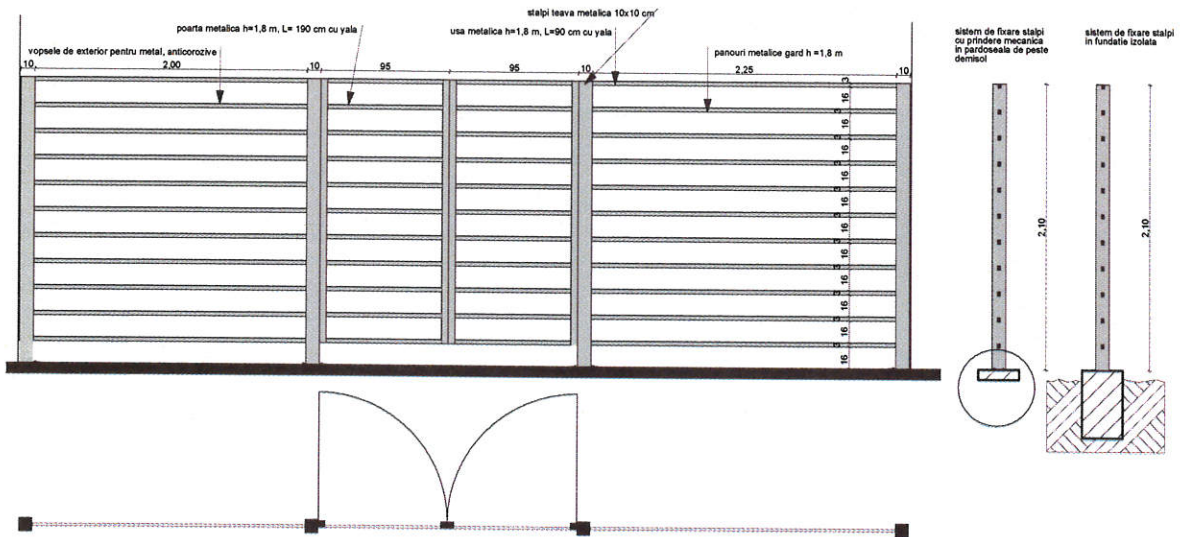

atelierul
ARHITEXT srl

ASOCIATIA ARHITECTURILOR
din Timisoara
3297
Ionel Petru
POP
Arhitect

OBIECT 4

DETALII DE EXECUTIE



MODERNIZARE TERASE EXISTENTE,
MONTARE TERMOSISTEM LA FATADE
SI EXTINDERE PE ORIZONTALA CU
CORPURI CONSTRUCTIE D SI E IN
REGIM P+2E+E_r LA SCOALA
GIMNAZIALA NR. 30

BENEFICIAR:
SCOALA GIMNAZIALA NR.30 TIMISOARA,
STRADA ASTRILOR, NR. 13, TIMISOARA

ARHITECTURA
Faza: AC, PT, DE, LC, CS

46. TRAPA AUTOMATA DE EVACUARE FUM IN CASA SCARII 100 cm x100 cm

1. strat dublu de sticlă acrilică (PMMA)
2. cadru din aluminiu pentru fixarea straturilor de PMMA
3. balama NIRO
4. guler metalic (AlMg3 cu 2,5 mm grosime) pentru o mai bună etanșeizare
5. soclu, tip N, din oțel zincat cu grosimea de 2 mm, vopsit la exterior RAL 9002, termoizolat cu vată minerală (3 cm grosime)
6. termoizolație

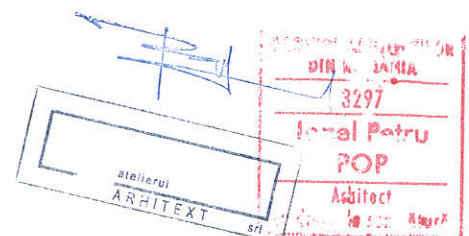
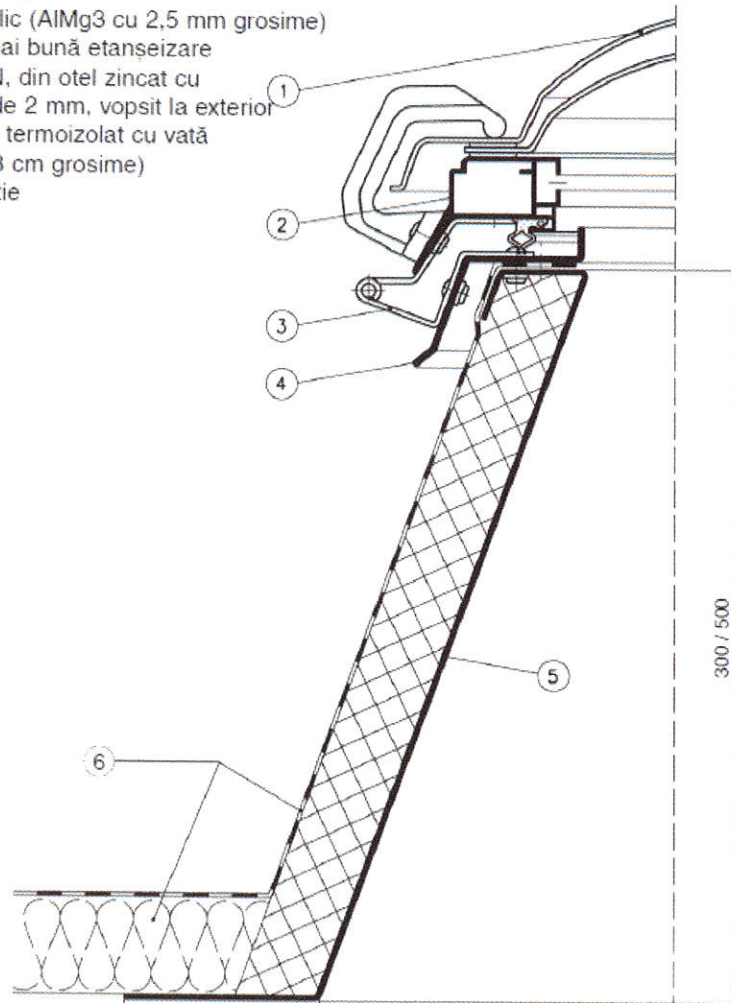

OBIECT 4

DETALII DE EXECUTIE

atelierul
ARHITEXT
adresa: localitatea Dumbravă, jud. Timiș
Str. Mesteacănului, nr.8

MODERNIZARE TERASE EXISTENTE,
MONTARE TERMOSISTEM LA FATADE
SI EXTINDERE PE ORIZONTALA CU
CORPURI CONSTRUCTIE D SI E IN
REGIM P+2E+Er LA SCOALA
GIMNAZIALA NR. 30

BENEFICIAR:
SCOALA GIMNAZIALA NR.30 TIMISOARA,
STRADA ASTRILOR, NR. 13, TIMISOARA

ARHITECTURA
Faza: AC, PT, DE, LC, CS

47. TRAPA CU CAPAC TERMOIZOLANT PENTRU VIZITARE BAZIN APA PSI -100 cm x100 cm

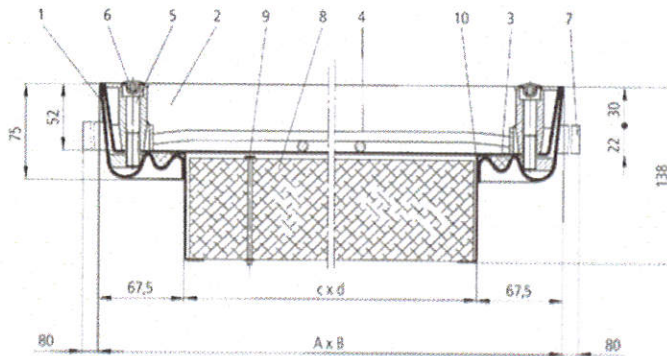

- 1 Ramă
- 2 Vană
- 3 Garnitură
- 4 Armătură
- 5 Șurub cu cap hexagonal înecat
- 6 Capac de acoperire
- 7 Ancoră
- 8 Placă izolatoare cu piesă unghiulară în "Z"
- 9 Bucălă de prindere pe trau placa izolatoare
- 10 Piesă unghiulară în "Z" din aluminiu



Type BV steel, scale 1 : 2,5

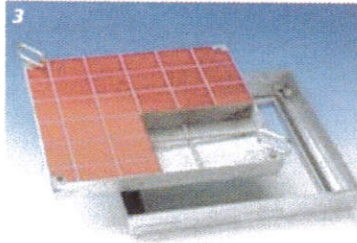

Type	Clear dimensions of shaft (= cm)	Outside dimensions (= cm)	Weight empty approx.	S/O*
	c x d	A x B		
BV 33	30 x 30	43,5 x 43,5	10 kg	S
BV 44	40 x 40	53,5 x 53,5	13 kg	S
BV 45	45 x 45	58,5 x 58,5	16 kg	S
BV 55	50 x 50	63,5 x 63,5	17 kg	S
BV 64	60 x 40	73,5 x 53,5	17 kg	S
BV 66	60 x 60	73,5 x 73,5	21 kg	S
BV 635	63,5 x 63,5	77,0 x 77,0	22 kg	S
BV 86	80 x 60	93,5 x 73,5	27 kg	S
BV 88	80 x 80	93,5 x 93,5	31 kg	S
BV 106	100 x 60	113,5 x 73,5	31 kg	S
BV 108	100 x 80	113,5 x 93,5	37 kg	S
BV 110	100 x 100	113,5 x 113,5	42 kg	S

Cover depth = 5,0 cm
Installation height = 7,5 cm
Special sizes possible
*S = available from stock
*O = to order

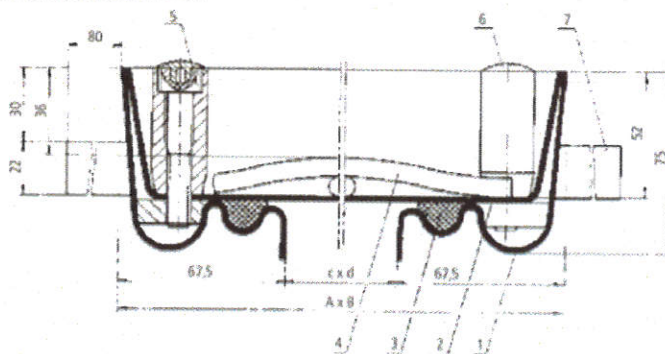

- 1 Frame
- 2 Cover
- 3 Seal
- 4 Reinforcement
- 5 Allen screw
- 6 Plastic cap
- 7 Anchor



OBIECT 4

DETALII DE EXECUTIE

atelierul
ARHITEXT srl
adresa: localitatea Dumbravita, jud. Timis
Str. Mesteacanului, nr.6

MODERNIZARE TERASE EXISTENTE,
MONTARE TERMOSISTEM LA FATADE
SI EXTINDERE PE ORIZONTALA CU
CORPURI CONSTRUCTIE D SI E IN
REGIM P+2E+Er LA SCOALA
GIMNAZIALA NR. 30

BENEFICIAR:
SCOALA GIMNAZIALA NR.30 TIMISOARA,
STRADA ASTRILOR, NR. 13, TIMISOARA

ARHITECTURA
Faza: AC, PT, DE, LC, CS

48. TRAPA CU CAPAC TERMOIZOLANT PENTRU VIZITARE STATIE POMPE -150 cm x150 cm

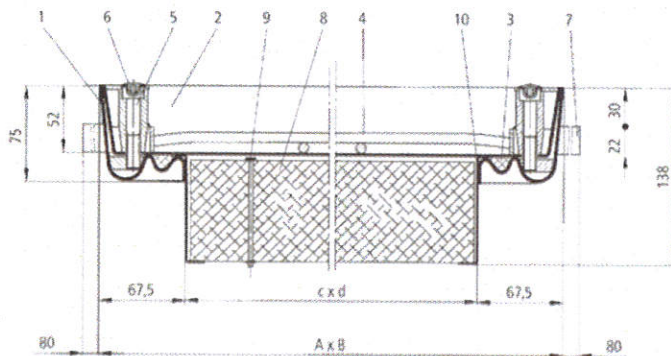

- 1 Ramă
- 2 Vană
- 3 Garnitură
- 4 Armătură
- 5 Șurub cu cap hexagonal înecat
- 6 Capac de acoperire
- 7 Ancoră
- 8 Placă izolatoare cu piesă unghiulară în "Z"
- 9 Bucă de prindere pe tru placa izolatoare
- 10 Piesă unghiulară în "Z" din aluminiu

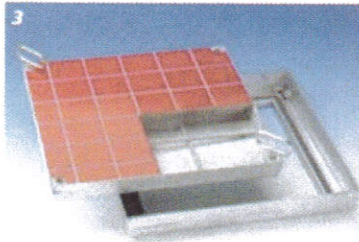

Type BV steel, scale 1 : 2,5

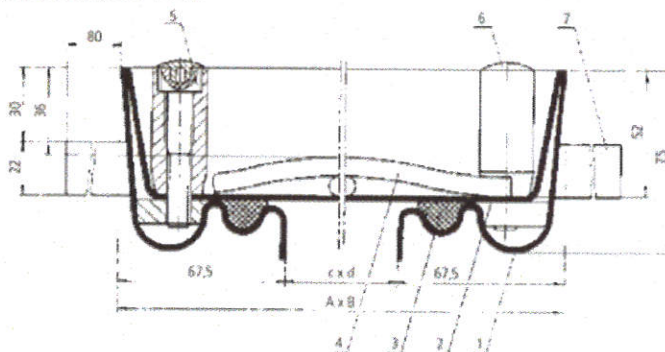

Type	Clear dimensions of shaft (= cm)	Outside dimensions (= cm)	Weight empty approx.
	c x d	A x B	
BV 33	30 x 30	43,5 x 43,5	10 kg S
BV 44	40 x 40	53,5 x 53,5	13 kg S
BV 45	45 x 45	58,5 x 58,5	16 kg S
BV 55	50 x 50	63,5 x 63,5	17 kg S
BV 64	60 x 40	73,5 x 53,5	17 kg S
BV 66	60 x 60	73,5 x 73,5	21 kg S
BV 635	63,5 x 63,5	77,0 x 77,0	22 kg S
BV 86	80 x 60	93,5 x 73,5	27 kg S
BV 88	80 x 80	93,5 x 93,5	31 kg S
BV 106	100 x 60	113,5 x 73,5	31 kg S
BV 108	100 x 80	113,5 x 93,5	37 kg S
BV 110	100 x 100	113,5 x 113,5	42 kg S

Cover depth = 5,0 cm
Installation height = 7,5 cm
Special sizes possible
* S = available from stock
* O = to order

- 1 Frame
- 2 Cover
- 3 Seal
- 4 Reinforcement
- 5 Allen screw
- 6 Plastic cap
- 7 Anchor

